



Manufacturer & Exporter of  
Dental Instruments

**DELIVERING PRODUCTS TO THE HEALING HANDS**



# **Extracting Forceps**



## 101 Extracting Forceps - English Pattern



**SGS 101-001**  
Fig 19  
upper wisdoms

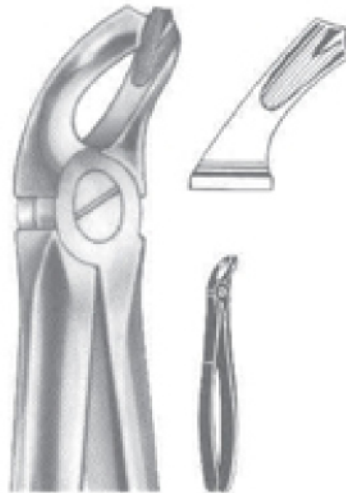

**SGS 101-002**  
Fig 20  
lower wisdoms

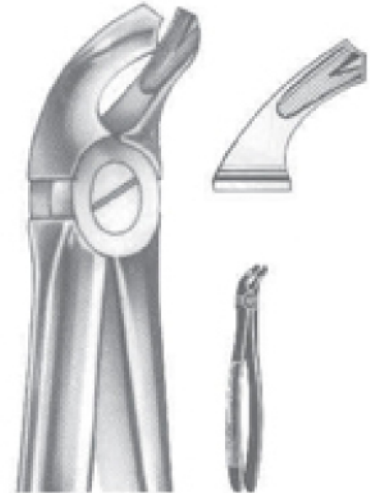

**SGS 101-003**  
Fig 21  
lower molars



**SGS 101-004**  
Fig 22  
lower molars



**SGS 101-005**  
Fig 22 A  
Albrecht  
lower molars



## 101 Extracting Forceps - English Pattern



**SGS 101-006**  
Fig 8  
lower premolars



**SGS 101-007**  
Fig 13  
lower premolars



**SGS 101-008**  
Fig 17  
upper molars, right



**SGS 101-009**  
Fig 18  
upper molars, left

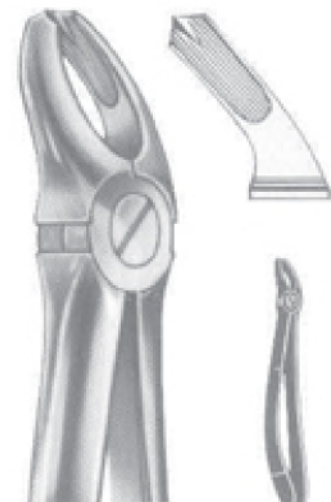

**SGS 101-010**  
Fig 18 A  
upper molars



## 101 Extracting Forceps - English Pattern



**SGS 101-011**  
Fig 33 A  
Lower Roots



**SGS 101-012**  
Fig 33 B  
Lower Roots

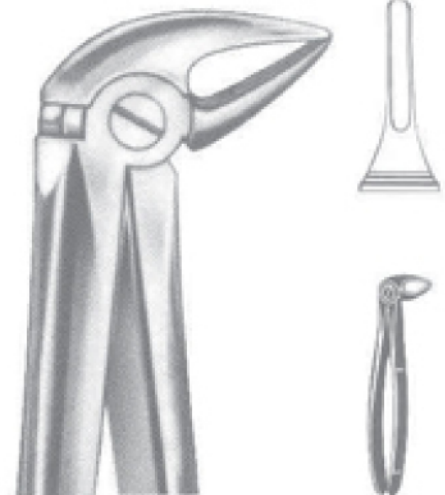

**SGS 101-013**  
Fig 33 L  
Lower Roots



**SGS 101-014**  
Fig 33 L  
Lower Roots



**SGS 101-015**  
Fig 33 S  
Lower Roots, for Children



## 101 Extracting Forceps - English Pattern



**SGS 101-016**  
Fig 44  
Upper Roots

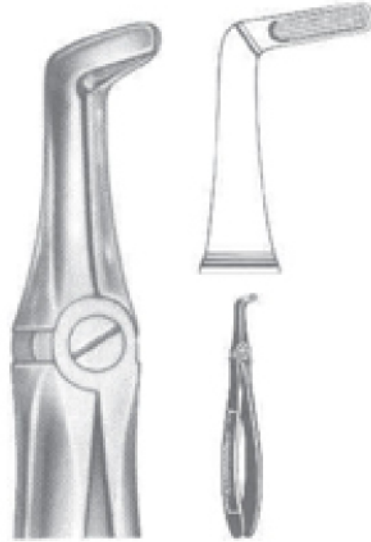

**SGS 101-017**  
Fig 45  
Lower Roots

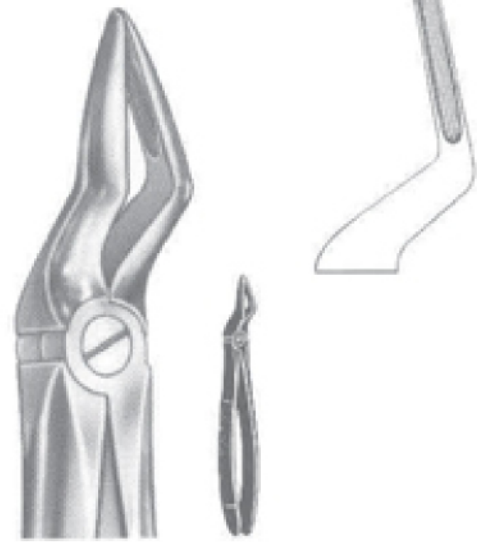

**SGS 101-018**  
Fig 12  
Upper Roots

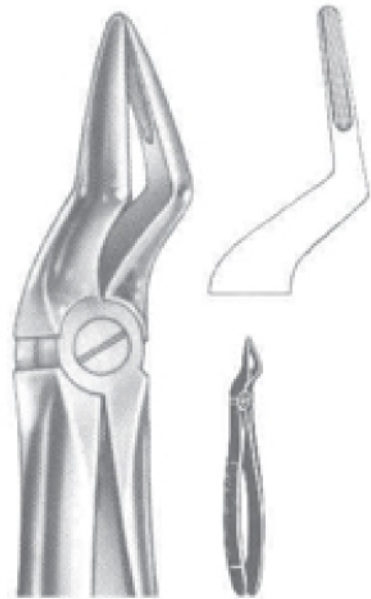

**SGS 101-019**  
Fig 51 A  
Upper Roots

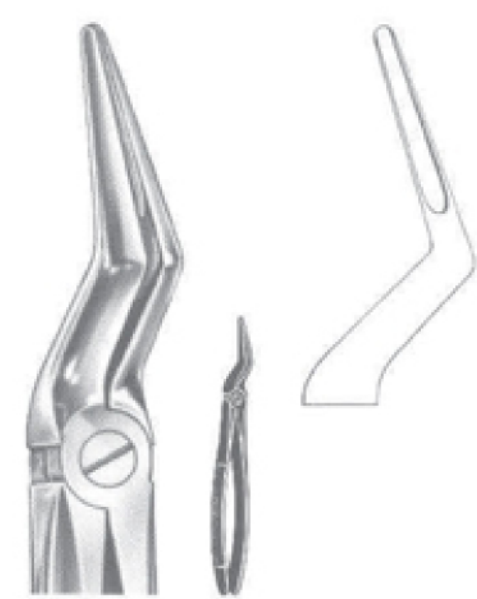

**SGS 101-020**  
Fig 51 L  
Upper Roots



## 101 "Relax" - Extracting Forceps



**Relax**  
**SGS 101-021**  
Fig 51  
Upper Roots

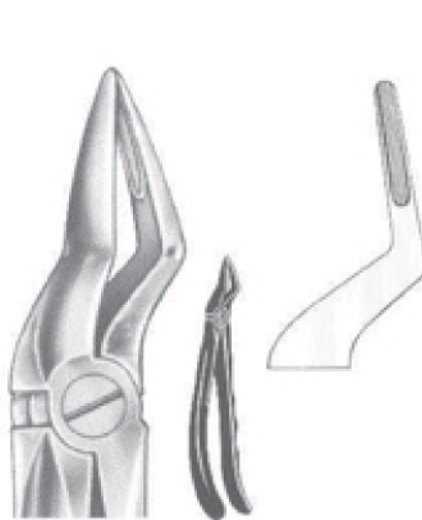

**Relax**  
**SGS 101-022**  
Fig 51 A  
Upper Roots



**Relax**  
**SGS 101-023**  
Fig 51 L  
Upper Roots



**Relax**  
**SGS 101-024**  
Fig 67  
Upper Wisdoms

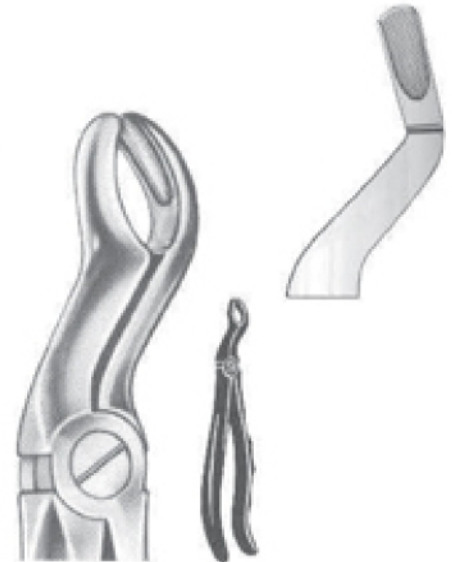

**Relax**  
**SGS 101-025**  
Fig 67 A  
Upper Wisdoms



## 101 Extracting Forceps For Children - English Pattern



**SGS 101-026**  
Fig 37  
Upper Incisors

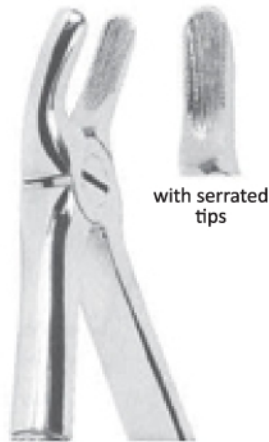

**SGS 101-027**  
Fig 39  
Upper Molars

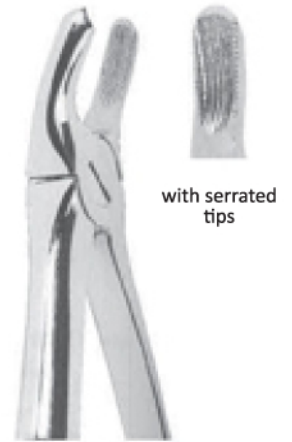

**SGS 101-028**  
Fig 39 R  
Upper Molars, Right

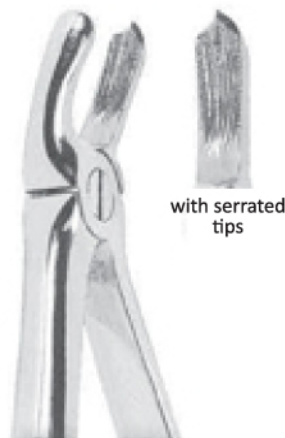

**SGS 101-029**  
Fig 39 L  
Upper Molars, Left

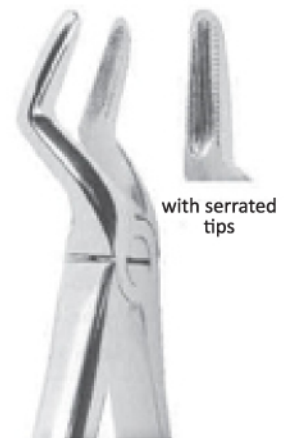

**SGS 101-030**  
Fig 515  
Upper Roots





## 101 Extracting Forceps For Children - English Pattern



**Klein**  
**SGS 101-031**  
Fig 6  
Lower Molars



**Klein**  
**SGS 101-032**  
Fig 137  
Upper Incisors



**Klein**  
**SGS 101-033**  
Fig 5  
Lower Incisors

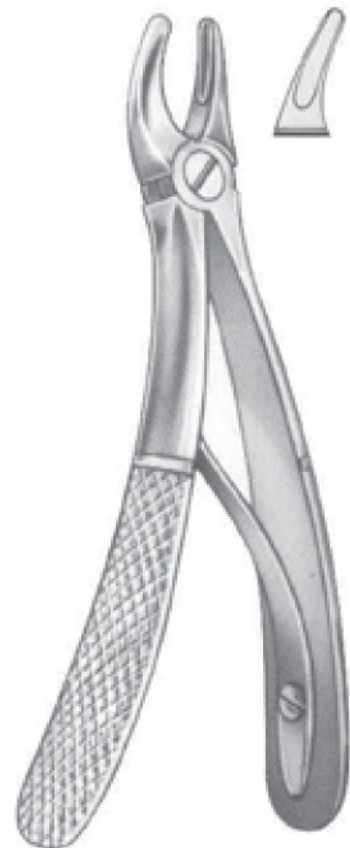

**Klein**  
**SGS 101-034**  
Fig 139  
Upper Premolars



## 101 Extracting Forceps - English Pattern



with serrated tips

**SGS 101-035**  
Fig 43 A  
Fractured or decayed upper teeth



with serrated tips

**SGS 101-036**  
Fig 44  
Upper Roots



with serrated tips

**SGS 101-037**  
Fig 45  
Lower Roots

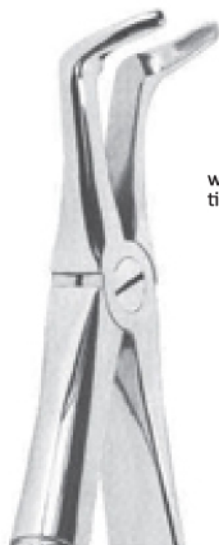

with serrated tips

**SGS 101-038**  
Fig 46  
Lower Roots



with serrated tips

**SGS 101-039**  
Fig 46 L  
Lower Roots



## 101 Extracting Forceps - English Pattern



**SGS 101-040**  
Fig 59  
Lower Roots

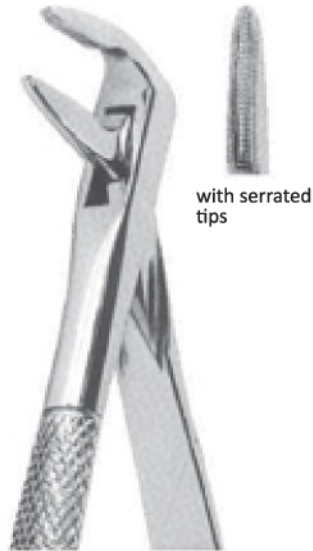

**SGS 101-041**  
Fig 59 L  
Lower Icisor  
Roots

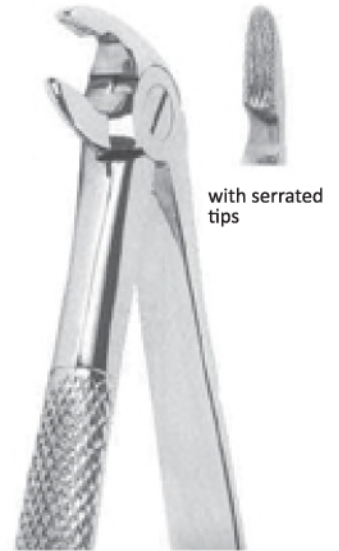

**SGS 101-042**  
Fig 60  
Lower Roots

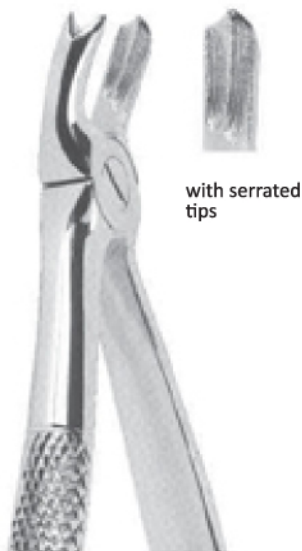

**SGS 101-043**  
Fig 65 L  
Upper Molars, Left

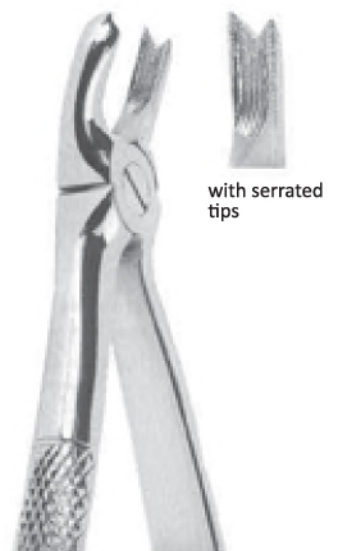

**SGS 101-044**  
Fig 65 R  
Upper Molars, Right





## 101 Extracting Forceps - English Pattern



**SGS 101-045**  
Fig 66 L  
Upper Molars, Left

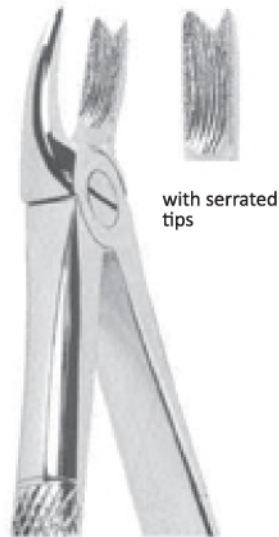

**SGS 101-046**  
Fig 66 R  
Upper Molars, Right



**SGS 101-047**  
Fig 67  
Upper Thire Molars



**SGS 101-048**  
Fig 67 A  
Upper Third Molars



**SGS 101-049**  
Fig 68  
Lower Roots



## 101 Extracting Forceps - English Pattern



**SGS 101-050**  
Fig 67½ L  
Upper Third Molars, Left

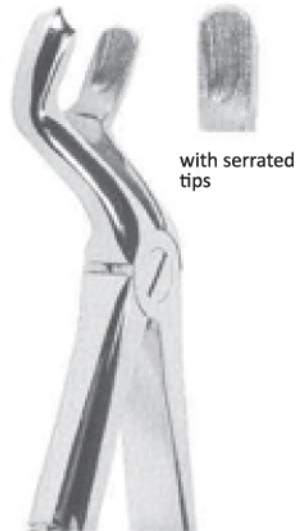

**SGS 101-051**  
Fig 67½ R  
Upper Third Molars, Right



**SGS 101-052**  
Fig 73  
Lower Molars

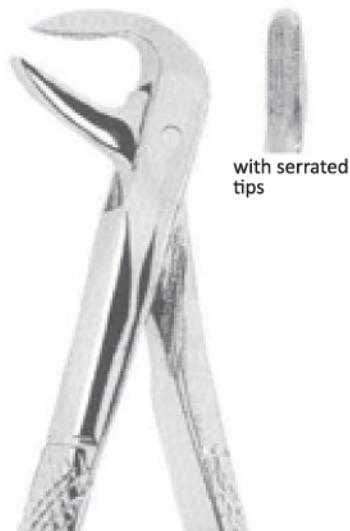

**SGS 101-053**  
Fig 74  
Lower Roots

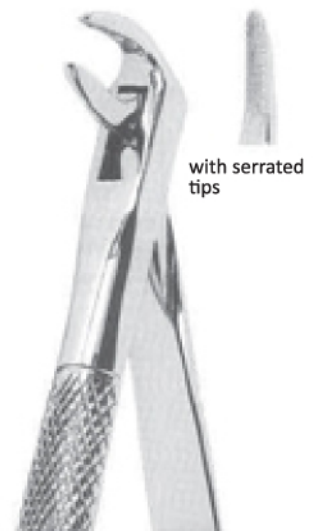

**SGS 101-054**  
Fig 74 M  
Lower Roots



## 101 Extracting Forceps - English Pattern



**SGS 101-055**  
Fig 74 N  
Lower Roots



with serrated tips



**SGS 101-056**  
Fig 75  
Lower Canines and Premolars



with serrated tips



**SGS 101-057**  
Fig 79  
Lower Third Molars



with serrated tips



**SGS 101-058**  
Fig 79 A  
Lower Third Molars



with serrated tips



**SGS 101-059**  
Fig 79 C  
Lower Third Molars



with serrated tips



## 101 Extracting Forceps - English Pattern

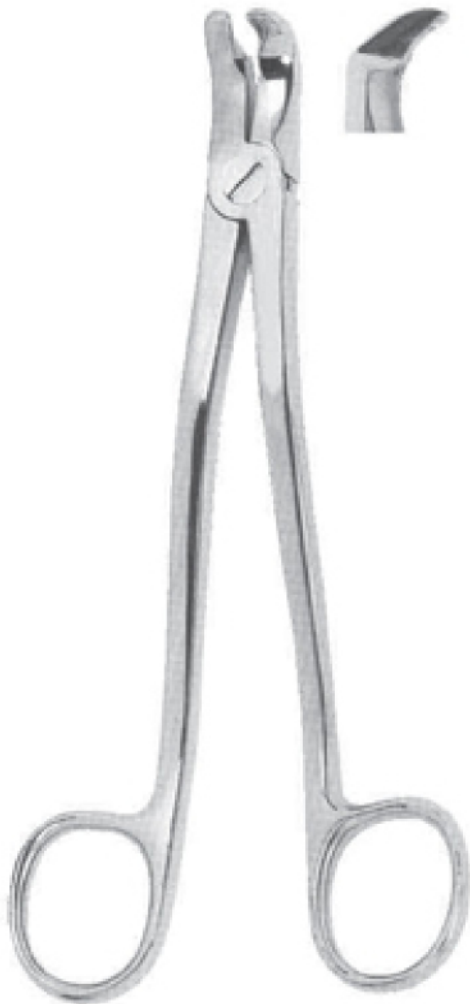

**SGS 101-060**  
Fig 86 W  
Lower Third Molars



**SGS 101-061**  
Fig 86 1/2 L  
Lower Third Molars, Left



**SGS 101-062**  
Fig 86 1/2 R  
Lower Third Molars, Right



**SGS 101-063**  
Fig 86 C  
Lower Molars



## 101 Extracting Forceps - English Pattern



with serrated tips

**SGS 101-064**

Fig 87

Lower Decayed Molars  
or Broken-Down Crowns

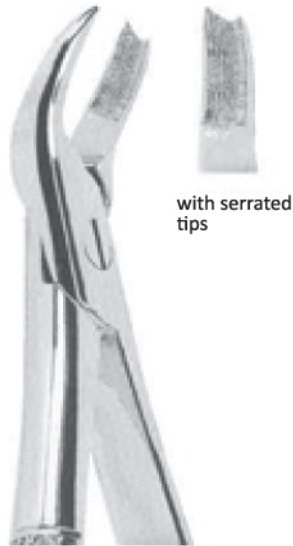

with serrated tips

**SGS 101-065**

Fig 89

Upper Molars, Right

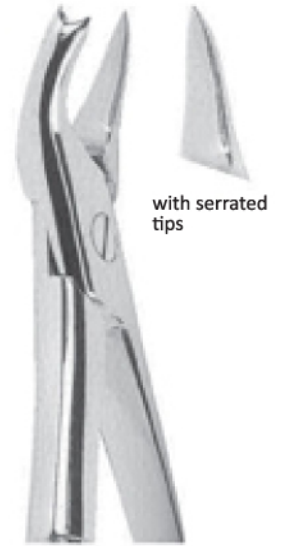

with serrated tips

**SGS 101-066**

Fig 90

Upper Molars, Left

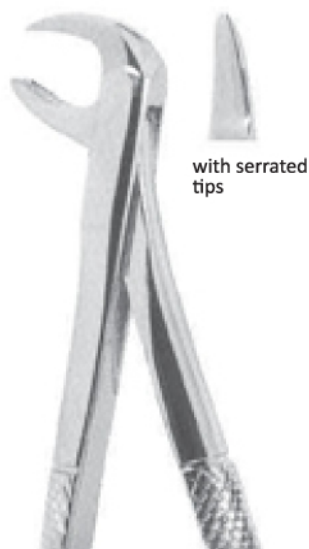

with serrated tips

**SGS 101-067**

Fig 99

Broken-Down Lower Molars

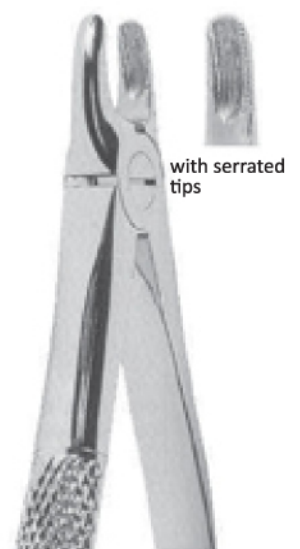

with serrated tips

**SGS 101-068**

Fig 107

Upper Canines





## 101 Extracting Forceps - English Pattern



**SGS 101-069**  
Fig 121  
Upper Third Molars



**SGS 101-070**  
Fig 145  
Upper Roots



**SGS 101-071**  
Fig 151½  
Upper Roots



**SGS 101-072**  
Fig 166  
Universal extracting forceps  
for upper teeth, in particular molars  
and premolars



**SGS 101-073**  
Fig 167  
Universal extracting forceps  
for upper teeth, in particular molars  
and premolars



## 101 Extracting Forceps - English Pattern



with serrated tips

**SGS 101-074**  
Fig 168  
Upper Canines

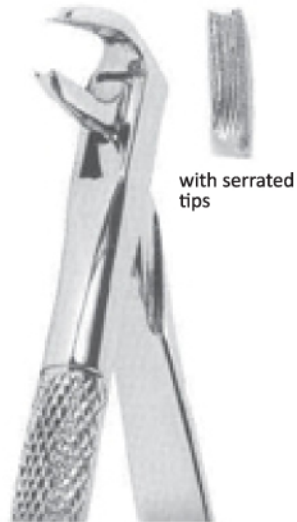

with serrated tips

**SGS 101-075**  
Fig 169  
Lower Canines

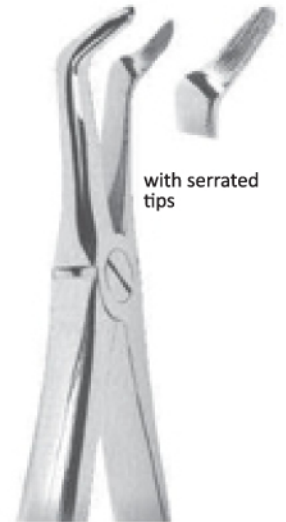

with serrated tips

**SGS 101-076**  
Fig 346  
Lower Roots

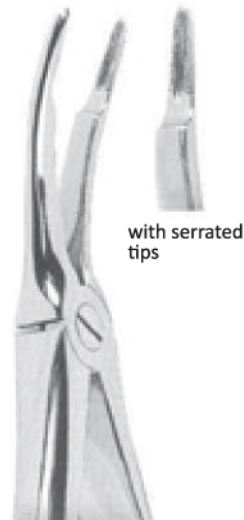

with serrated tips

**SGS 101-077**  
Fig 349  
Upper Roots



with serrated tips

**SGS 101-078**  
Fig 359  
Lower Roots



## 101 Extracting Forceps - Mead Pattern



with serrated tips

**SGS 101-079**

Fig 1

Universal extracting forceps for upper incisors & canines



with serrated tips

**SGS 101-080**

Fig 2

upper molars

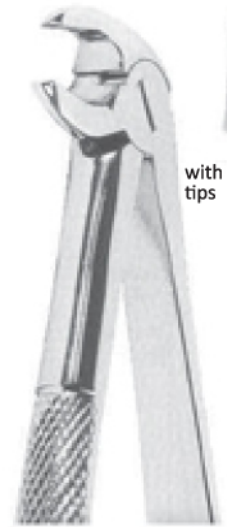

with serrated tips

**SGS 101-081**

Fig 3

lower incisors, premolars and roots



with serrated tips

**SGS 101-082**

Fig 4

lower molars



## 101 Extracting Forceps With Anatomically Shaped Handle



**SGS 101-083**  
Fig 1  
upper incisors  
and canines

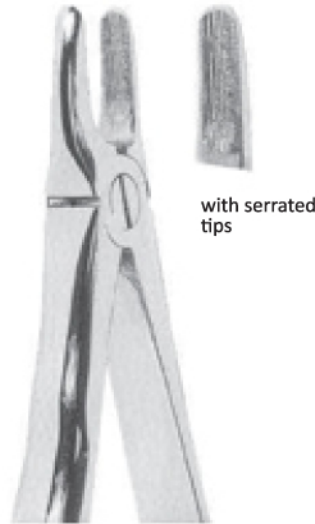

**SGS 101-084**  
Fig 2  
upper incisors  
and canines

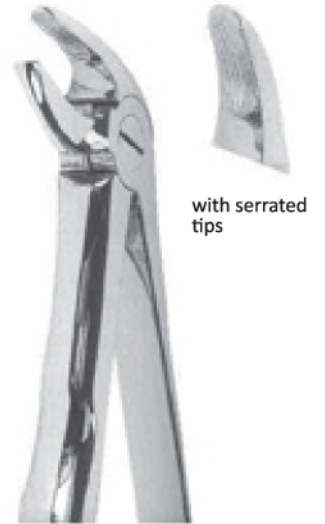

**SGS 101-085**  
Fig 4  
lower incisors  
and canines

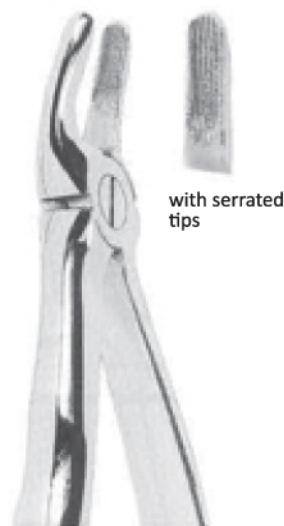

**SGS 101-086**  
Fig 7  
lower premolars



**SGS 101-087**  
Fig 13  
lower premolars





## 101 Extracting Forceps With Anatomically Shaped Handle



**SGS 101-088**  
Fig 17  
upper molars, right

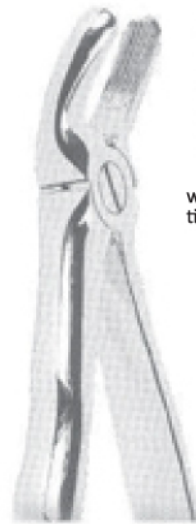

with serrated tips

**SGS 101-089**  
Fig 18  
upper molars, left

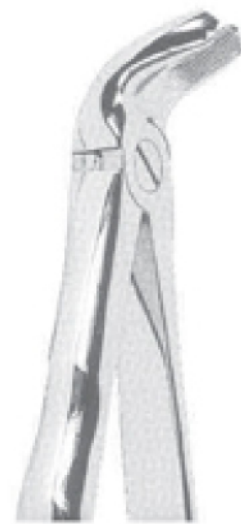

with serrated tips

**SGS 101-090**  
Fig 21  
lower molars

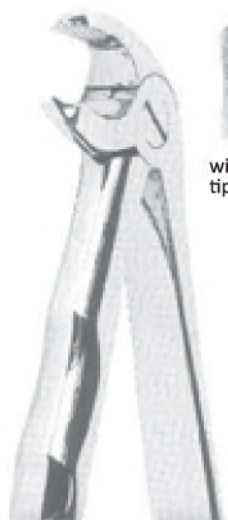

with serrated tips

**SGS 101-091**  
Fig 22  
lower molars

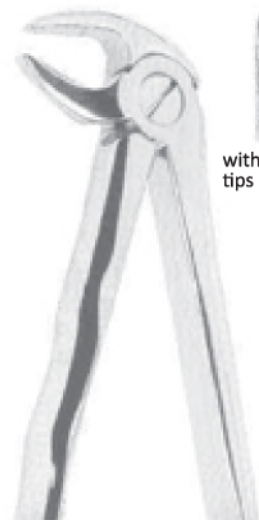

with serrated tips

**SGS 101-092**  
Fig 33  
lower roots



## 101 Extracting Forceps With Anatomically Shaped Handle



with serrated tips

**SGS 101-093**  
Fig 89  
upper molars, right

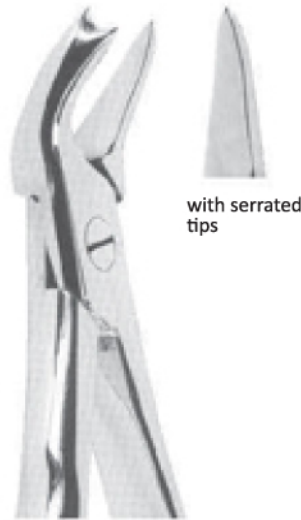

with serrated tips

**SGS 101-094**  
Fig 90  
upper molars, left

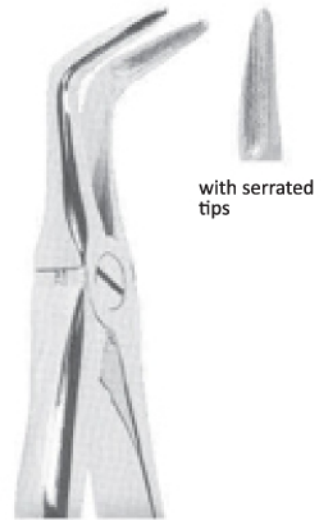

with serrated tips

**SGS 101-095**  
Fig 145  
lower roots

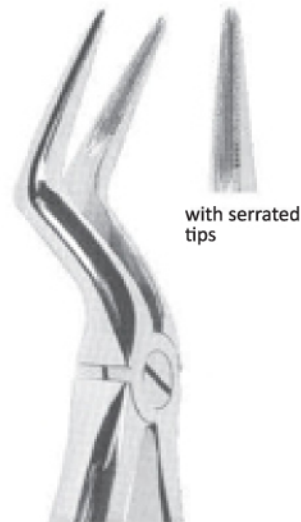

with serrated tips

**SGS 101-096**  
Fig 151½  
upper roots

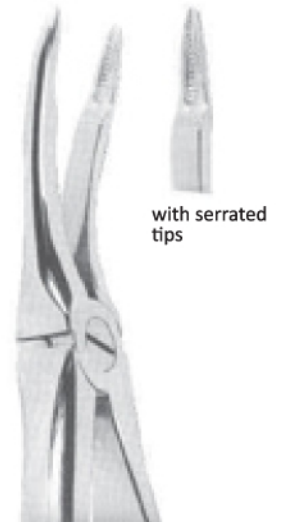

with serrated tips

**SGS 101-097**  
Fig 349  
upper roots



## 101 Extracting Forceps With Anatomically Shaped Handle



**SGS 101-098**  
Fig 45  
lower roots



with serrated tips



**SGS 101-099**  
Fig 51 A  
upper roots

with serrated tips



**SGS 101-100**  
Fig 67 A  
upper third molars

with serrated tips

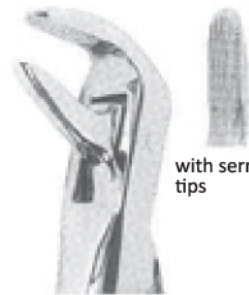

**SGS 101-101**  
Fig 74  
lower roots

with serrated tips



**SGS 101-102**  
Fig 79  
lower third molars

with serrated tips

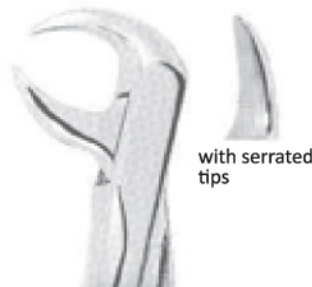

**SGS 101-103**  
Fig 86 C  
lower molars

with serrated tips

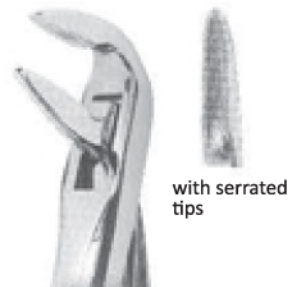

**SGS 101-104**  
Fig 359  
lower roots

with serrated tips



## 101 Extracting Forceps - American Pattern



**SGS 101-105**  
Fig 5  
lower third molars



**SGS 101-106**  
Fig 6  
separating forceps



**SGS 101-107**  
Fig 105  
upper molars



**SGS 101-108**  
Fig 16  
lower molars



**SGS 101-109**  
Fig 17  
lower molars





## 101 Extracting Forceps - American Pattern



**SGS 101-110**  
Fig 18 L  
upper molars, left



**SGS 101-111**  
Fig 18 R  
upper molars, right



**SGS 101-112**  
Fig 23  
lower molars



**SGS 101-113**  
Fig 53 R  
upper molars, right



**SGS 101-114**  
Fig 53 L  
upper molars, left



## 101 Extracting Forceps - American Pattern



**SGS 101-115**  
Fig 65  
upper incisors & roots



**SGS 101-116**  
Fig 69  
upper & lower roots



**SGS 101-117**  
Fig 88 R  
upper molars, right



**SGS 101-118**  
Fig 88 L  
upper molars, left



**SGS 101-119**  
Fig 101  
deciduous teeth



## 101 Extracting Forceps - American Pattern



**SGS 101-120**  
Fig 150  
upper incisors,  
premolars, roots



**SGS 101-121**  
Fig 150 S  
upper teeth (for children)

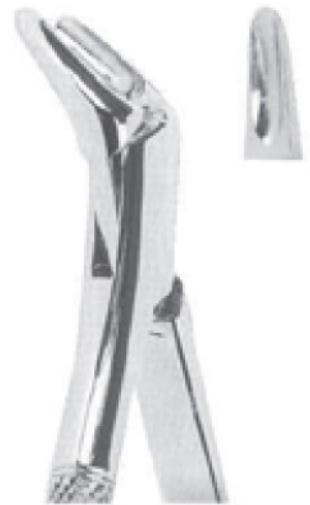

**SGS 101-122**  
Fig 151  
upper incisors,  
premolars, roots



**SGS 101-123**  
Fig 151 S  
lower teeth (for children)



**SGS 101-124**  
Fig 222  
lower third molars



## 101 Extracting Forceps - American Pattern



**SGS 101-125**  
Fig 1  
upper incisors  
& bicuspid

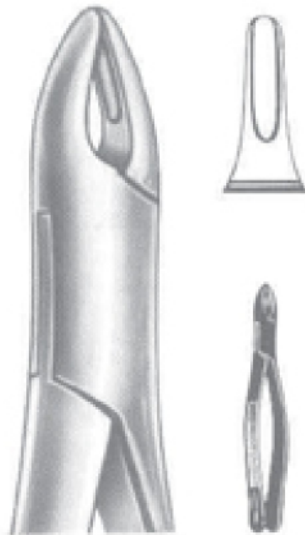

**SGS 101-126**  
Fig 1 B  
upper roots, anterior



**SGS 101-127**  
Fig 5  
lower wisdoms



**SGS 101-128**  
Fig 6  
lower molars,  
splitting forceps



**SGS 101-129**  
Fig 10 H  
upper molars



## 101 Extracting Forceps for Children - English Pattern



with serrated tips

**SGS 101-130**  
Fig 10 H  
lower premolars



**SGS 101-131**  
Fig 10 H  
lower molars



**SGS 101-132**  
Fig 10 H  
upper incisors  
and roots



with serrated tips

**SGS 101-133**  
Fig 10 H  
lower roots



with serrated tips

**SGS 101-134**  
Fig 10 H  
lower incisors  
and canines



## 101 Extracting Forceps for Children - Klein Pattern



**SGS 101-135**  
Fig 1  
upper incisors



**SGS 101-136**  
Fig 2  
upper premolars



**SGS 101-137**  
Fig 3  
upper molars



**SGS 101-138**  
Fig 4  
upper roots



**SGS 101-139**  
Fig 5  
lower incisors

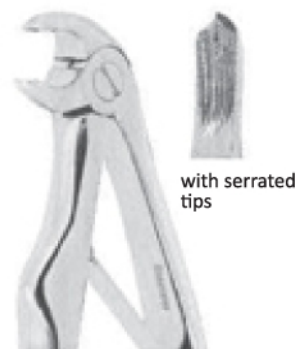

**SGS 101-140**  
Fig 6  
lower molars



**SGS 101-141**  
Fig 7  
lower roots



## 101 Root Splinter Extracting Forceps



**SGS 101-142**  
Fig 1  
lower roots



**SGS 101-143**  
Fig 2  
upper roots



**SGS 101-145**  
Fig 2  
roots fragments



**SGS 101-144**  
Fig 1  
roots fragments

# Root Elevators





## 120 Root Elevators

lower jaw, left side

lower jaw, right side



SGS 120-001



SGS 120-002

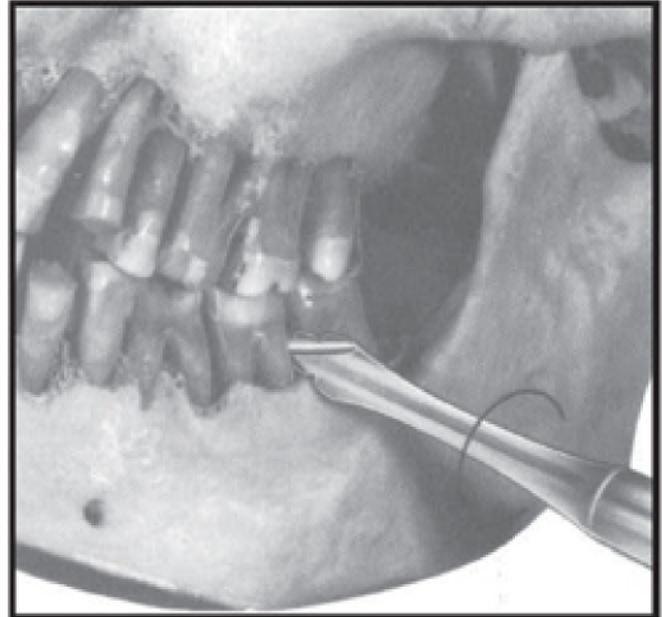

Root elevator, spiral-shaped, for extremely facilitated extraction of the molars in the lower jaw. the slender, conical points allow deep penetration between tooth and gum. Owing to the hook-shaped working parts, slipping of the elevators is avoided.



## 120 Root Elevators



**Bein**  
**SGS 120-003**  
Fig 1



**Bein**  
**SGS 120-004**  
Fig 2



**Bein**  
**SGS 120-005**  
Fig 0



**Bein**  
**SGS 120-006**  
Fig 3



**Bein**



**Bein**  
**SGS 120-007**  
Fig 5



**Bein**  
**SGS 120-008**  
Fig 5



**Bein**  
**SGS 120-009**  
Fig 6



120

## Root Elevators



Seldin



Seldin  
SGS 120-010  
Fig 1 L



Seldin  
SGS 120-011  
Fig 1 R



Seldin  
SGS 120-012  
Fig 2



Seldin  
SGS 120-013  
Fig 3



Seldin  
SGS 120-014  
Fig 4 L



Seldin  
SGS 120-015  
Fig 4 R



## 120 Root Elevators



Cryer



Cryer  
SGS 120-016  
Fig 4



Cryer  
SGS 120-017  
Fig 12



Cryer  
SGS 120-018  
Fig 27



Cryer  
SGS 120-019  
Fig 28



Cryer  
SGS 120-020  
Fig 27 S



Cryer  
SGS 120-021  
Fig 28 S



Apical



Apical  
SGS 120-022  
Fig 1



Apical  
SGS 120-023  
Fig 2



Apical  
SGS 120-024  
Fig 3



Apical  
SGS 120-025  
Fig 4



## 120 Root Elevators



**Cryer**



**Cryer**  
SGS 120-026  
Fig 1

**Cryer**  
SGS 120-027  
Fig 2



**Coupland**



**Coupland**  
SGS 120-028  
Fig 1

**Coupland**  
SGS 120-029  
Fig 2

**Coupland**  
SGS 120-030  
Fig 3



## 120 Root Elevators



**SGS 120-031**  
Fig 1



**SGS 120-032**  
Fig 2



**SGS 120-033**  
Fig 3



**Flohr**  
**SGS 120-034**  
Fig 1



**Flohr**  
**SGS 120-035**  
Fig 2



**Flohr**  
**SGS 120-036**  
Fig 3



## 120 Root Elevators



**Kopp**  
SGS 120-037  
Fig 1



**Kopp**  
SGS 120-038  
Fig 2



**Kopp**  
SGS 120-043  
Fig 1



**Kopp**  
SGS 120-044  
Fig 2



**Kopp**



**Kopp**  
SGS 120-039  
Fig 3



**Kopp**  
SGS 120-040  
Fig 4



**Kopp**



**Kopp**  
SGS 120-045  
Fig 3



**Kopp**  
SGS 120-046  
Fig 4



**Kopp**  
SGS 120-041  
Fig 5



**Kopp**  
SGS 120-042  
Fig 6





## 120 Root Elevators



**Hylin**  
SGS 120-047  
Fig 1

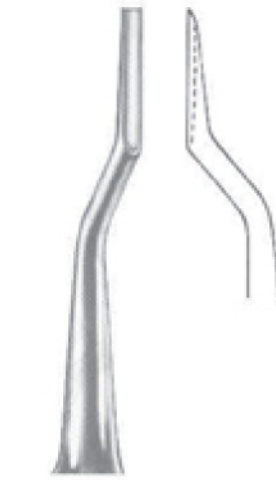

**Bein**  
SGS 120-049  
Fig 1

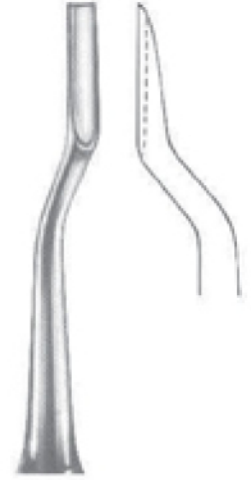

**Bein**  
SGS 120-050  
Fig 2



**Hylin**  
SGS 120-048  
Fig 2



**Bein**  
SGS 120-051  
Fig 3

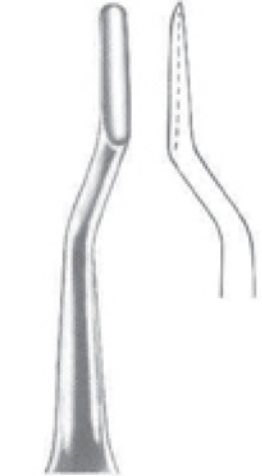
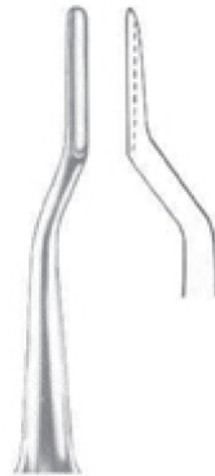

**Bein**  
SGS 120-052  
Fig 4



## 120 Root Elevators



**Warwick-James**  
SGS 120-053  
Fig 1



**Warwick-James**  
SGS 120-054  
Fig 2



**Warwick-James**  
SGS 120-055  
Fig 3



**London Hospital**  
SGS 120-056  
Fig 1



**London Hospital**  
SGS 120-057  
Fig 2



**London Hospital**  
SGS 120-058  
Fig 3



**Ott**  
SGS 120-059



120

## Root Elevators



Pott



Pott  
SGS 120-060  
Fig 1

Pott  
SGS 120-061  
Fig 2

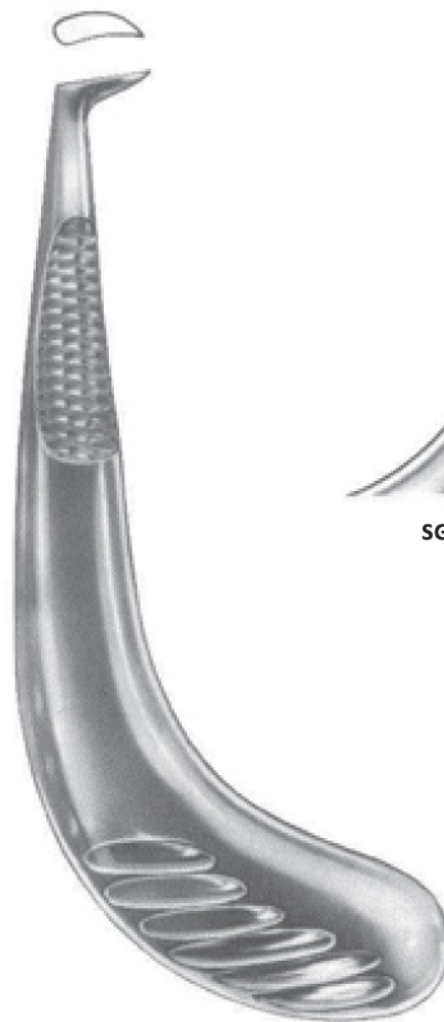

SGS 120-062  
Fig 1

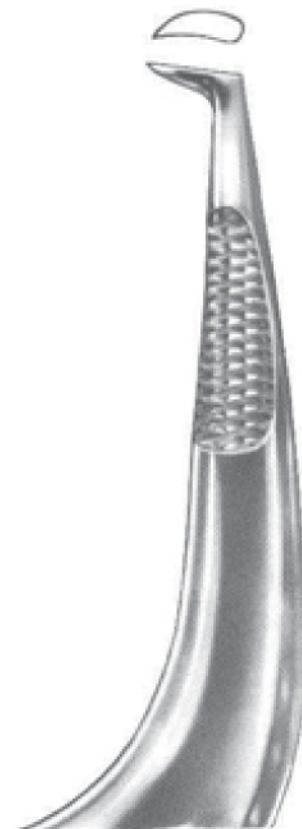

SGS 120-063  
Fig 2



## 120 Root Elevators



**Mead**  
**SGS 120-064**  
MD-1



**Mead**  
**SGS 120-065**  
MD-5 A



**Mead**  
**SGS 120-066**  
MD-6 A



**Mead**  
**SGS 120-067**  
MD-7 A



**Mead**  
**SGS 120-068**  
MD-8 A



**Lecluse**  
**SGS 120-069**



## 120 Root Elevators



Chompret  
SGS 120-070  
Fig 1



Chompret  
SGS 120-071  
Fig 2



Chompret  
SGS 120-072  
Fig 3



Chompret  
SGS 120-073  
Fig 4



Apical  
SGS 120-074



## 120 Root Elevators, Root Tip Elevators



**SGS 120-075**  
Fig 1



**SGS 120-076**  
Fig 2



**SGS 120-077**  
Fig 3



**Heidbrink**  
**SGS 120-078**  
Fig 1



**Heidbrink**  
**SGS 120-079**  
Fig 2



**Heidbrink**  
**SGS 120-080**  
Fig 3



## 120 Root Elevators



Winter  
SGS 120-081  
Fig 1 L



Winter  
SGS 120-082  
Fig 1 R



Winter  
SGS 120-083  
Fig 2 L



Winter  
SGS 120-084  
Fig 2 R



Winter



Winter  
SGS 120-085  
Fig 11 L



Winter  
SGS 120-086  
Fig 11 R



Winter  
SGS 120-087  
Fig 12 L



Winter  
SGS 120-088  
Fig 12 R



Winter  
SGS 120-089  
Fig 14 L



Winter  
SGS 120-090  
Fig 14 R



## 120 Root Elevators



**Barry**  
**SGS 120-092**  
Fig 1



**Barry**  
**SGS 120-093**  
Fig 2



**Barry**  
**SGS 120-094**  
Fig 3



**Barry**  
**SGS 120-095**  
Fig 4



**Barry**  
**SGS 120-091**  
Fig 14 R



**Barry**  
**SGS 120-096**  
Fig 11



**Barry**  
**SGS 120-097**  
Fig 12



**Barry**  
**SGS 120-098**  
Fig 17



**Barry**  
**SGS 120-099**  
Fig 18





## 120 Root Elevators



Cryer  
SGS 120-101  
Fig 26



Cryer  
SGS 120-102  
Fig 27



Cryer  
SGS 120-103  
Fig 28



Cryer  
SGS 120-104  
Fig 29



Cryer  
SGS 120-105  
Fig 22



Cryer  
SGS 120-106  
Fig 23



SGS 120-100



120

## Root Elevators



**Kopp**  
**SGS 120-108**  
Fig 31



**Kopp**  
**SGS 120-109**  
Fig 32



**Kopp**  
**SGS 120-110**  
Fig 33



**Kopp**  
**SGS 120-111**  
Fig 34



**Kopp**  
**SGS 120-112**  
Fig 35



**Kopp**  
**SGS 120-113**  
Fig 44



**SGS 120-107**



## 120 Root Elevators



**Heidbrinck**  
SGS 120-115  
Fig 10



**Winter**  
SGS 120-116  
Fig 11



**Winter**  
SGS 120-117  
Fig 12



**Barry**  
SGS 120-118  
Fig 17



**Barry**  
SGS 120-119  
Fig 18



**SGS 120-120**  
Fig 20



**SGS 120-114**



**120** Root Elevators



SGS 120-122



SGS 120-121



SGS 120-123

# Filling Instruments



## 130 Filling Instruments

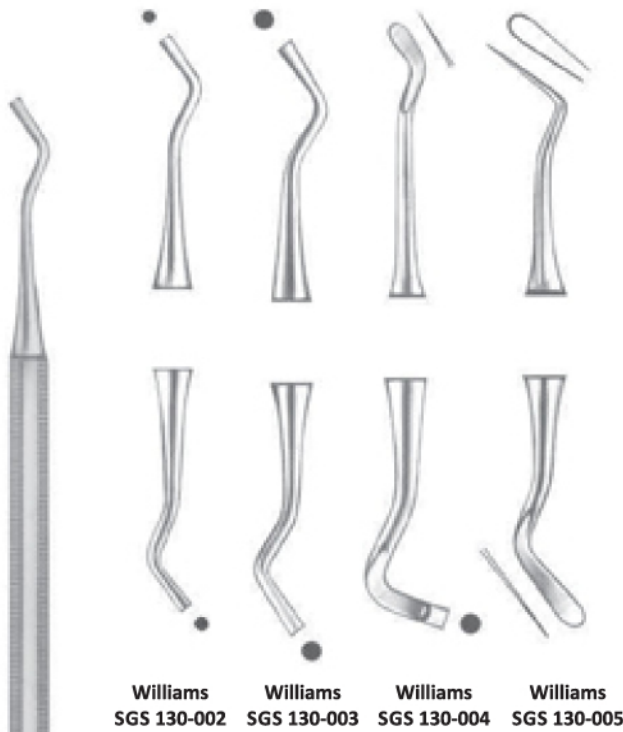

Williams SGS 130-002 Williams SGS 130-003 Williams SGS 130-004 Williams SGS 130-005

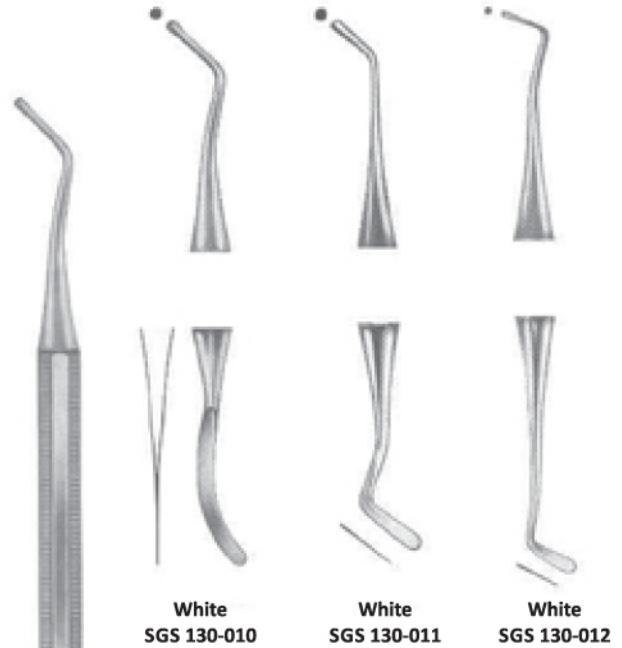

White SGS 130-010 White SGS 130-011 White SGS 130-012



Williams SGS 130-001 Williams SGS 130-006 Williams SGS 130-007 Williams SGS 130-008

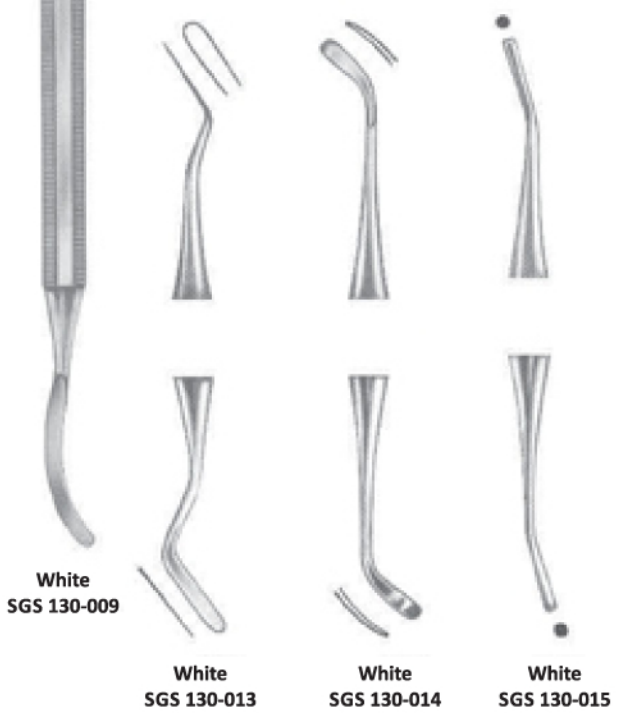

White SGS 130-009 White SGS 130-013 White SGS 130-014 White SGS 130-015



## 130 Filling Instruments

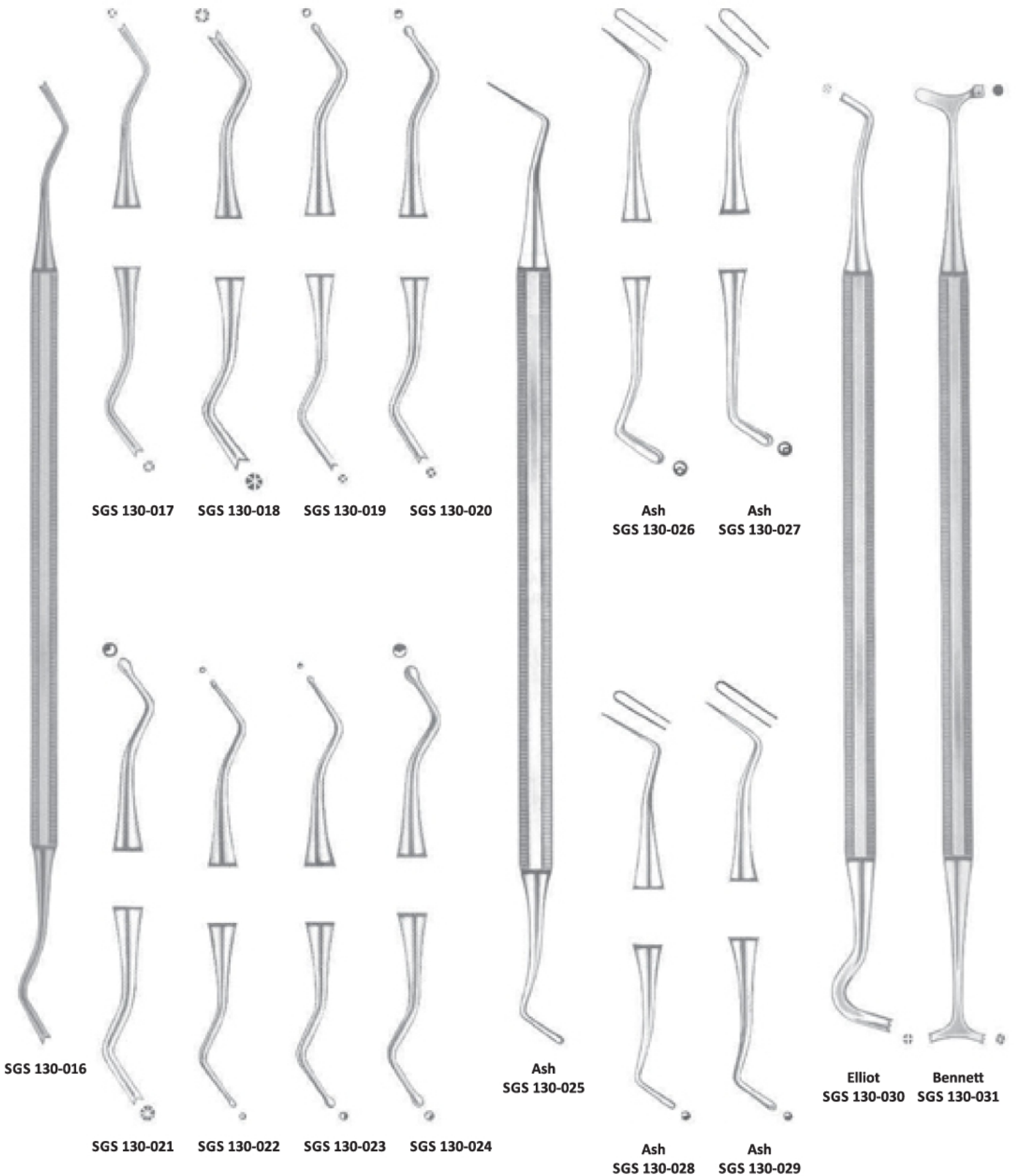



## 130 Filling Instruments

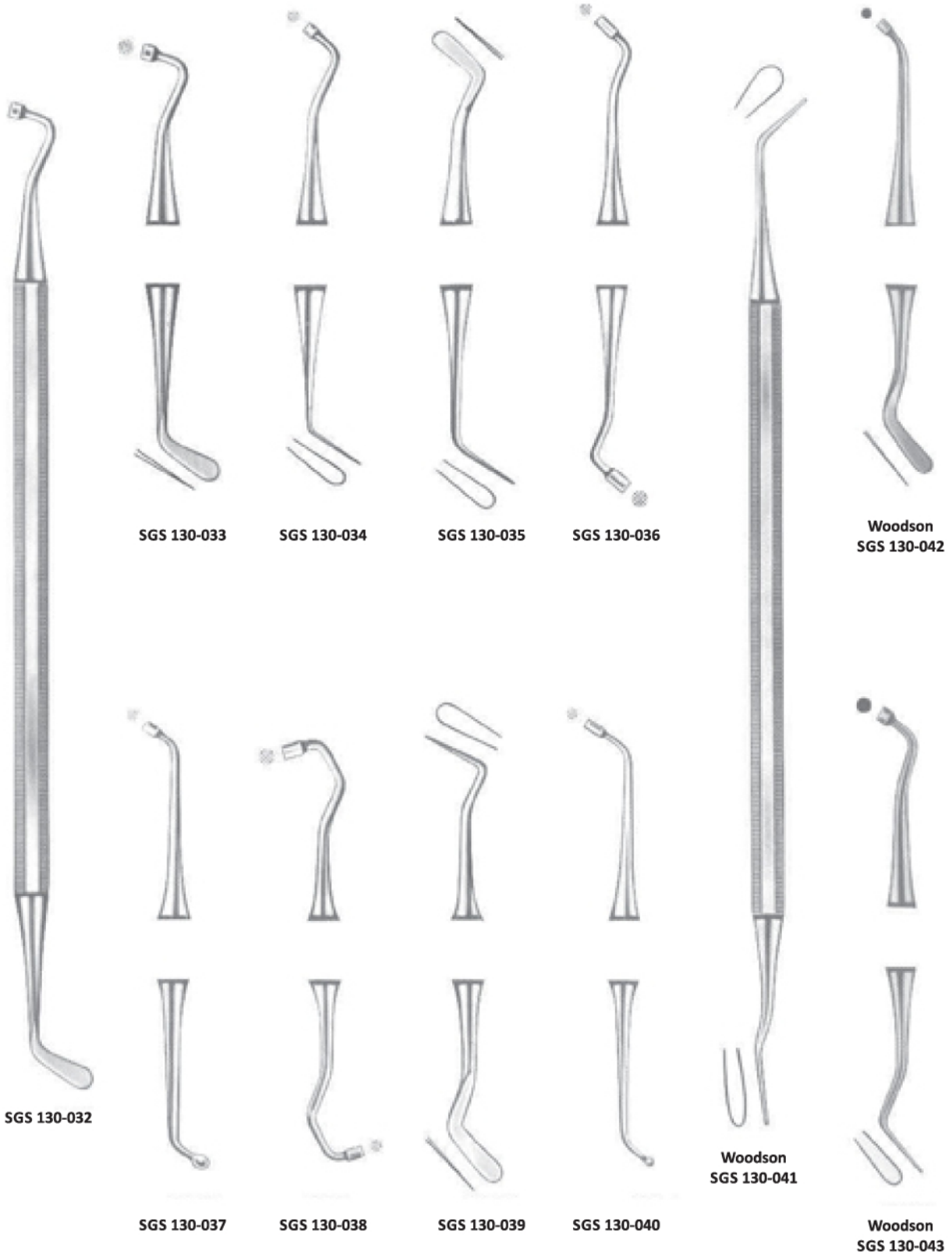





## 130 Filling Instruments



Heidemann  
SGS 130-044  
Fig 1



Heidemann  
SGS 130-045  
Fig 2



Heidemann  
SGS 130-046  
Fig 3



SGS 130-047



SGS 130-048  
Fig 146



SGS 130-050  
Fig 148



SGS 130-049  
Fig 147



SGS 130-051  
Fig 149



SGS 130-052  
Fig 158

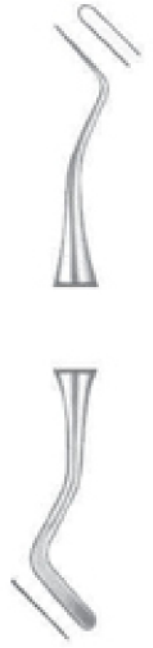

SGS 130-053  
Fig 159



SGS 130-054  
Fig 160



## 130 Filling Instruments



SGS 130-055  
Gracey



SGS 130-056  
Gracey



SGS 130-057  
Gracey



SGS 130-059  
Gracey



SGS 130-060  
Gracey



SGS 130-061  
Gracey



SGS 130-062  
Gracey



SGS 130-063



SGS 130-064  
Fig 18



SGS 130-065  
Fig 19



SGS 130-066  
Fig 20



SGS 130-067  
Fig 21



SGS 130-068  
Fig 23



SGS 130-069  
Fig 25



SGS 130-070  
Fig 26



SGS 130-071  
Fig 27

# **Dental Probes**



## 140 Dental Probes

with point set in



SGS 140-001



SGS 140-002



SGS 140-003



SGS 140-004



SGS 140-005



SGS 140-006



SGS 140-007



SGS 140-008



SGS 140-009



SGS 140-010



SGS 140-011



SGS 140-012



SGS 140-013  
Woodson



## 140 Burnishers and Pocket Probes Scalers

### Polishing Instruments

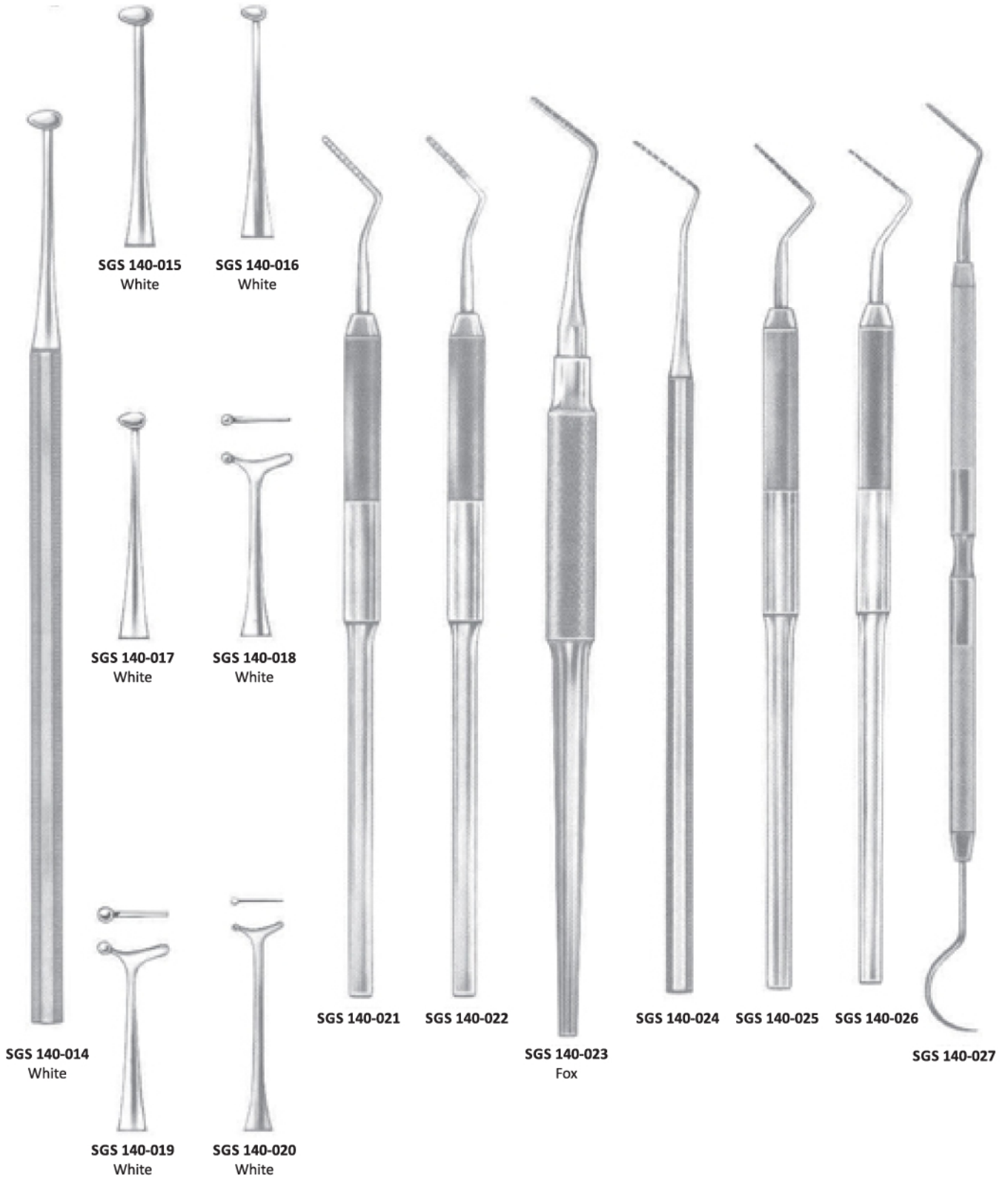



## 140 Periodontal Pocket Probes



- New marking process
- Laser system marking
- No more paint peeling off
- Permanent marking
- Antiglare, low depth marking
- maximum tip resistance against breaking



**SGS 140-028**  
Fig CP-C



**SGS 140-029**  
Fig CP-11



**SGS 140-030**  
Fig CP-12



**SGS 140-031**  
Fig CP-12 S  
O.M.S



## 140 Periodontal Pocket Probes

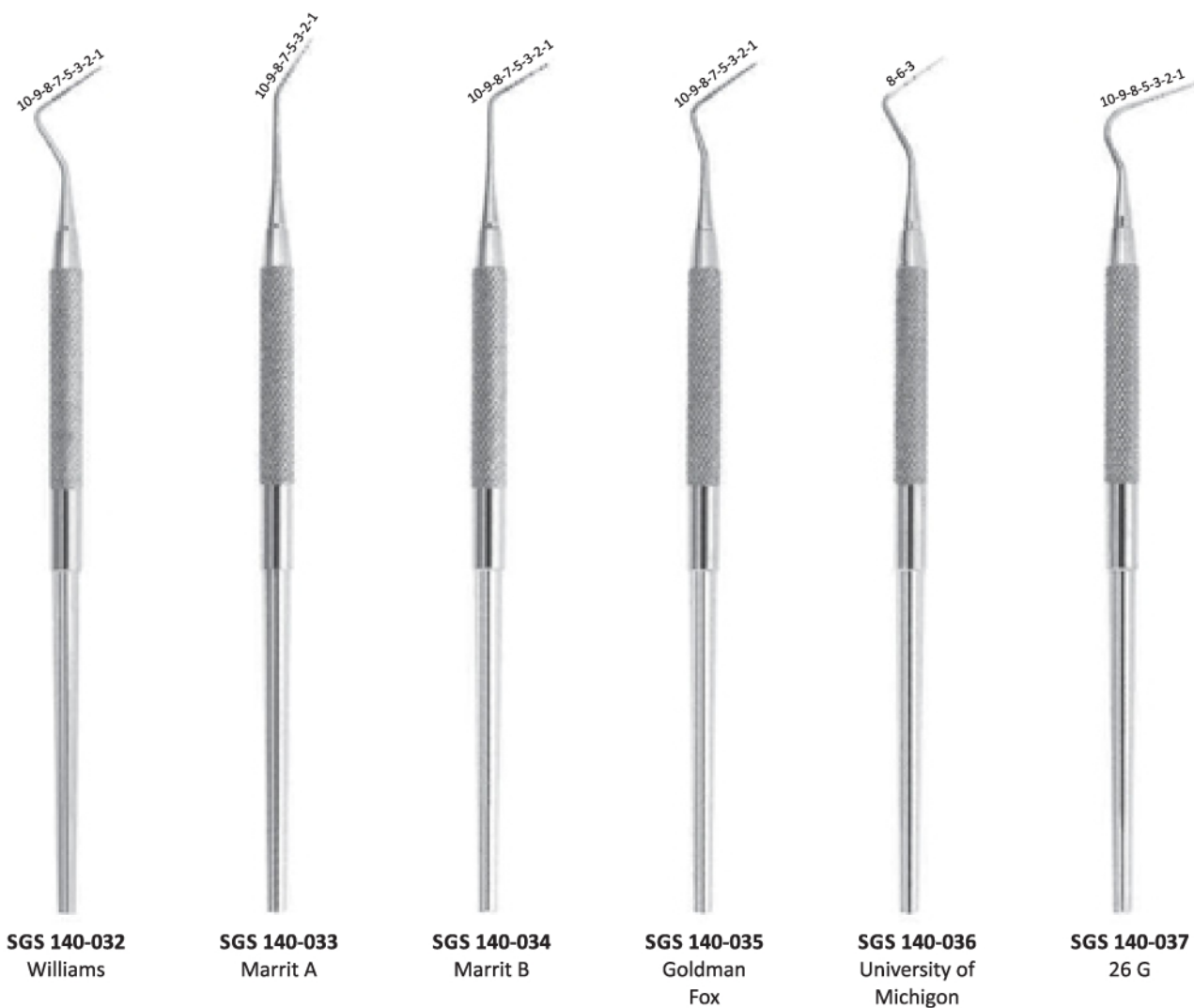

# **Periodontia Instruments**





## 150 Periodontia Instruments

Files

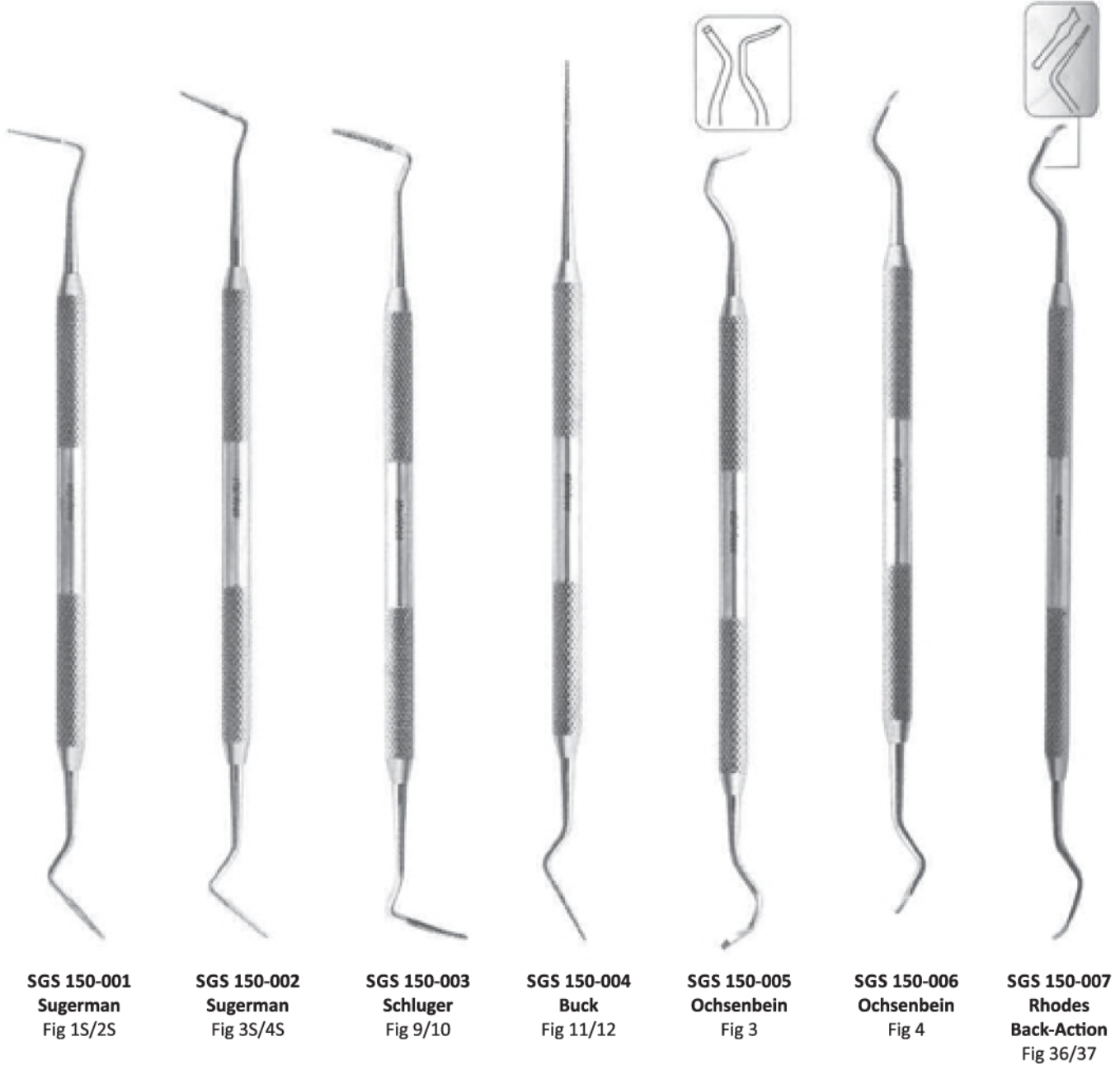



## 150 Periodontia Instruments

Files

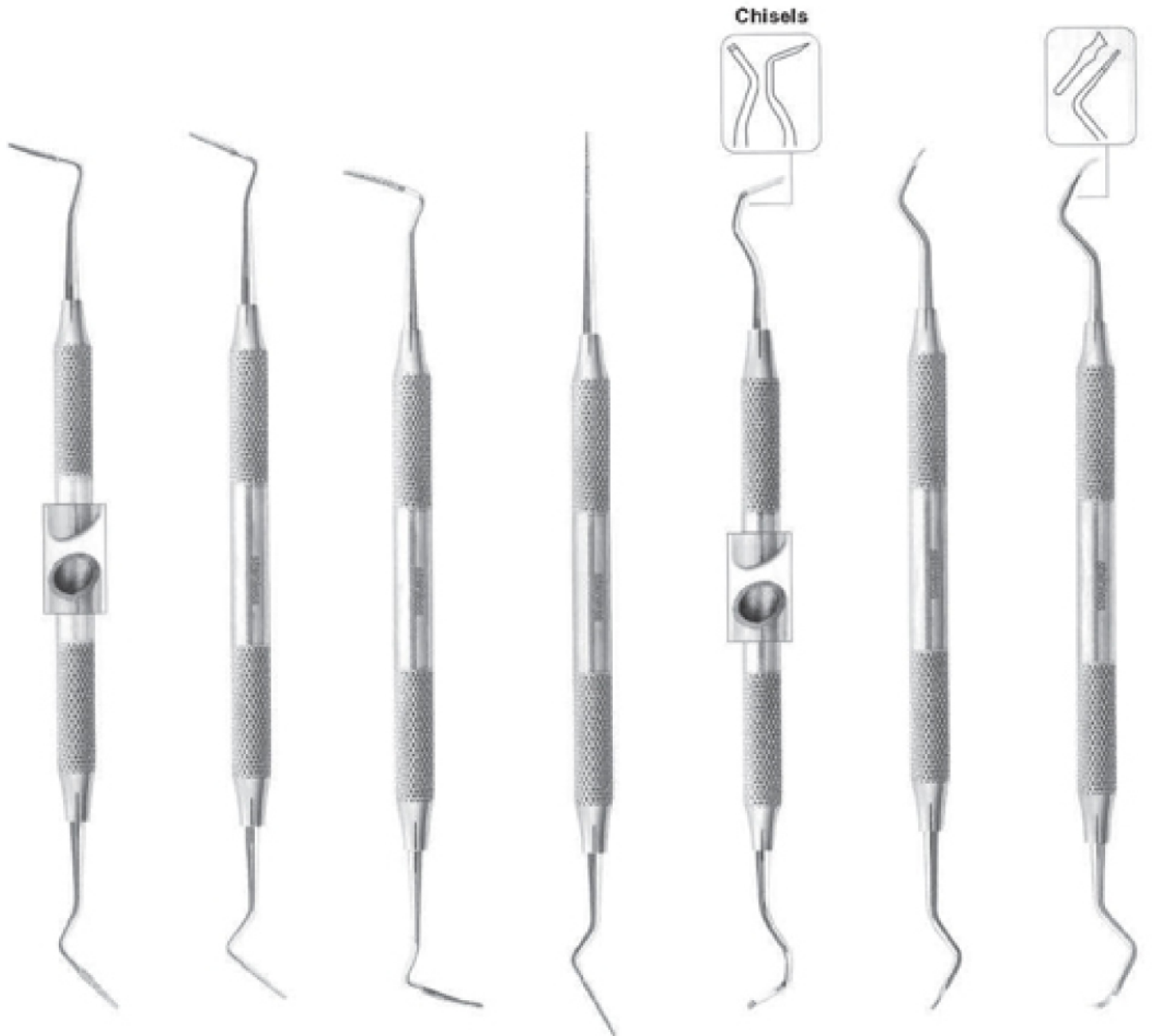

**SGS 150-008**  
Sugerman  
Fig 1S/2S

**SGS 150-009**  
Sugerman  
Fig 3S/4S

**SGS 150-010**  
Schluger  
Fig 9/10

**SGS 150-011**  
Buck  
Fig 11/12

**SGS 150-012**  
Ochsenbein  
Fig 3

**SGS 150-013**  
Ochsenbein  
Fig 4

**SGS 150-014**  
Rhodes  
Back-Action  
Fig 36/37



## 150 Periodontia Instruments

### Gingivectomy Knives



**SGS 150-015**  
Goldman  
Fox  
Fig 7



**SGS 150-016**  
Goldman  
Fox  
Fig 8



**SGS 150-017**  
Goldman  
Fox  
Fig 9



**SGS 150-018**  
Goldman  
Fox  
Fig 11



**SGS 150-019**  
Buck  
Fig 3/4



**SGS 150-020**  
Buck  
Fig 5/6



## 150 Periodontia Instruments

### Curettes and Scalers



**SGS 150-021**  
Currete  
Fig HU 1/2



**SGS 150-022**  
Columbia  
Fig 2R/2L



**SGS 150-023**  
Columbia  
Fig 4R/4L



**SGS 150-024**  
Columbia  
Fig 13/14



**SGS 150-025**  
Fig 413/412



**SGS 150-026**  
Fig 413/414



**SGS 150-027**  
Zerfing-Chisel



## 150 Periodontia Instruments

### Gingivectomy Knives

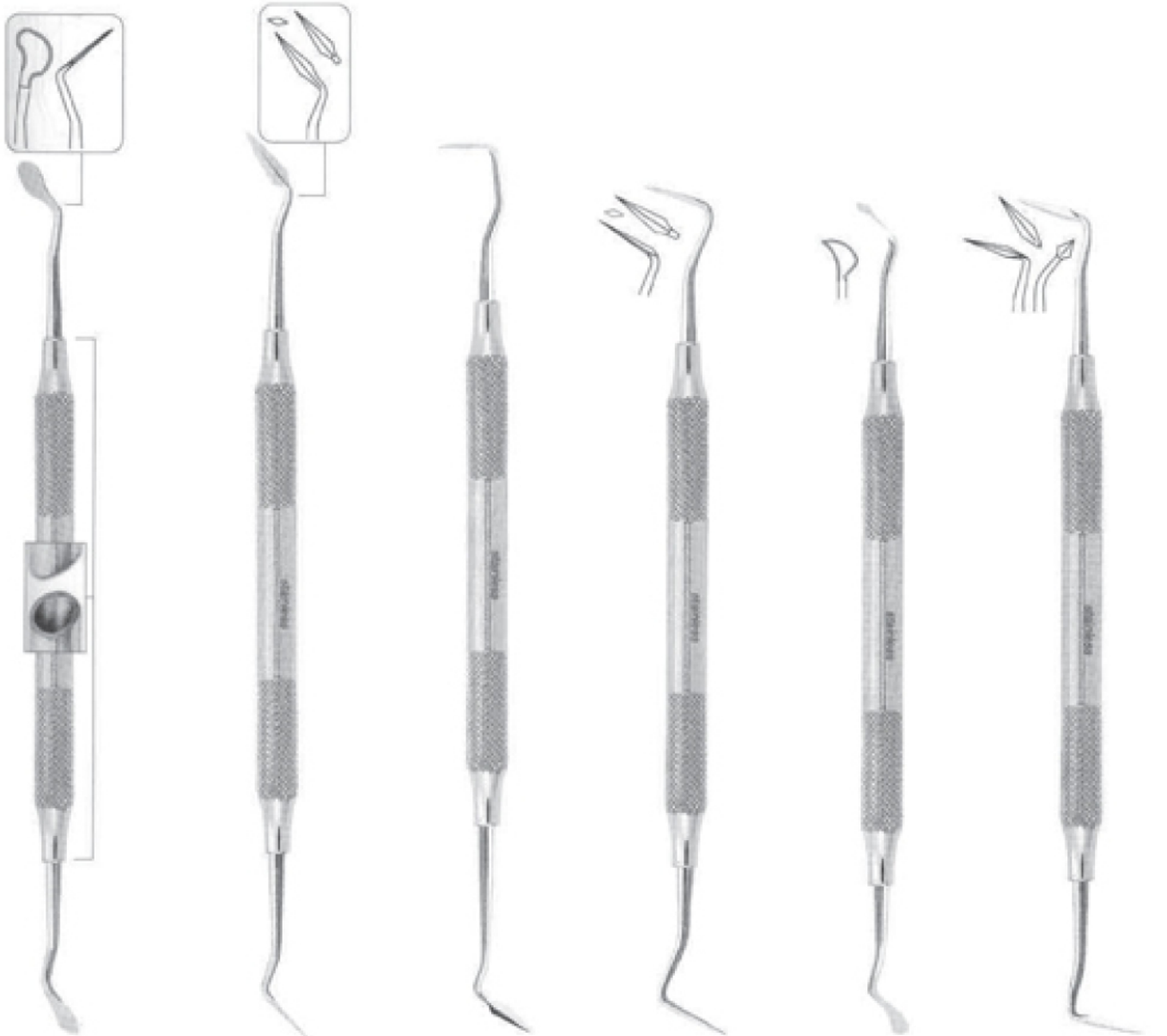

**SGS 150-028**  
Goldman - Fox  
Fig 7

**SGS 150-029**  
Goldman - Fox  
Fig 8

**SGS 150-030**  
Goldman - Fox  
Fig 9

**SGS 150-031**  
Goldman - Fox  
Fig 11

**SGS 150-032**  
Buck  
Fig 3/4

**SGS 150-033**  
Buck  
Fig 5/6



## 150 Periodontia Instruments

### Curettes and Scalers

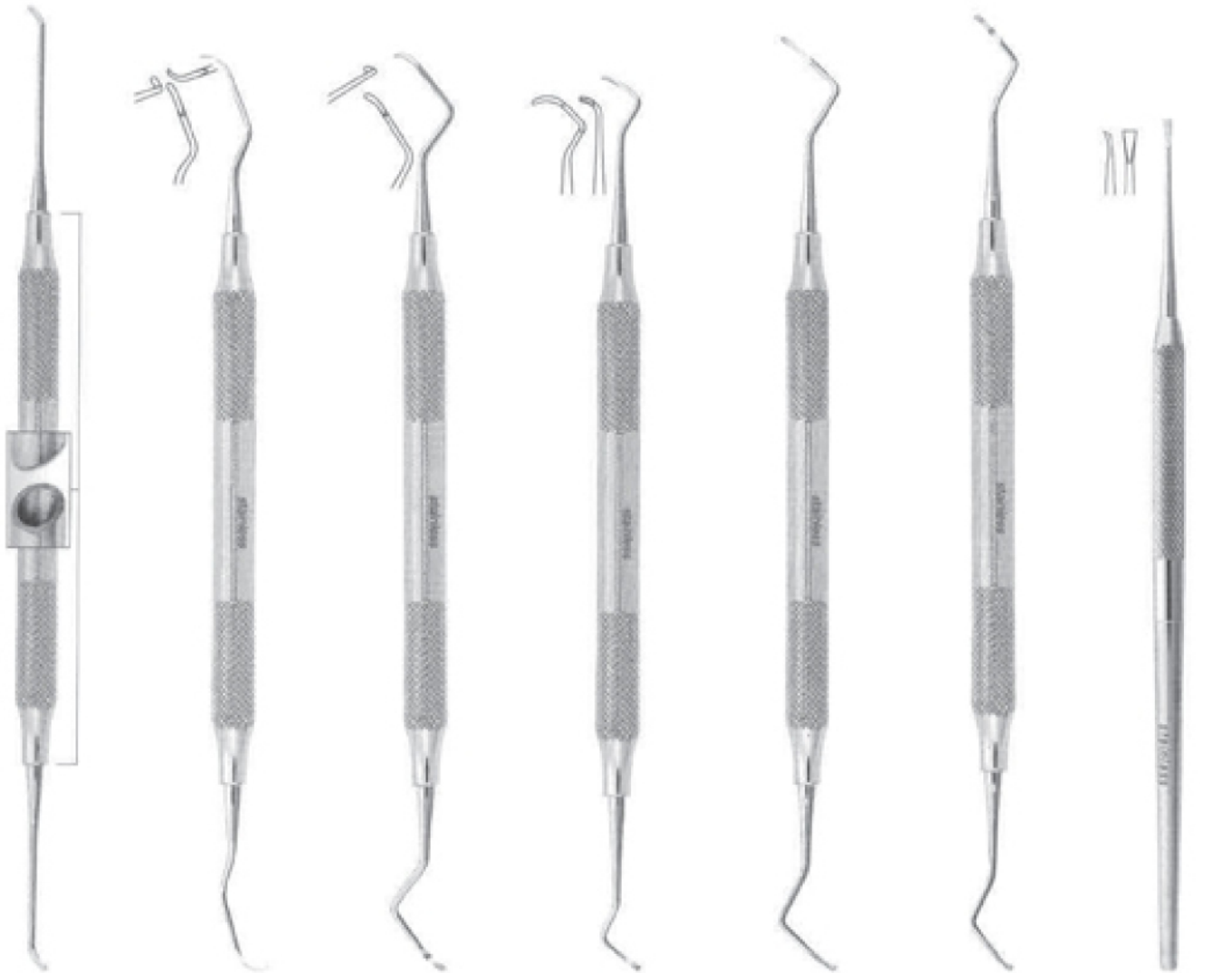

**SGS 150-034**  
Currete  
Fig HU 1/2

**SGS 150-035**  
Columbia  
Fig 2R/2L

**SGS 150-036**  
Columbia  
Fig 4R/4L

**SGS 150-037**  
Columbia  
Fig 13/14

**SGS 150-038**  
Fig 413/412

**SGS 150-039**  
Fig 413/414

**SGS 150-040**  
Zerfing-Chisel



## 150 Periodontia Instruments

### Bone Chisels and Gouges





## 150 Periodontia Instruments

### Bone Chisels and Gouges

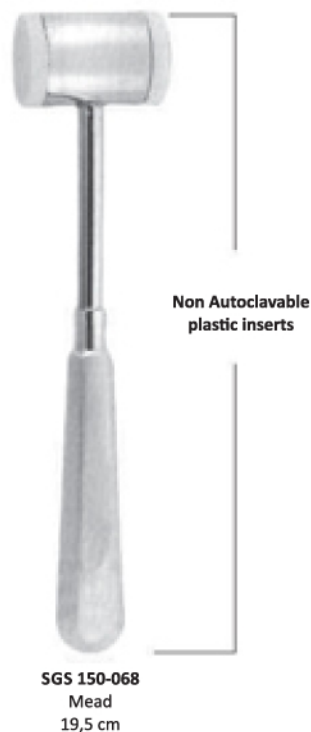
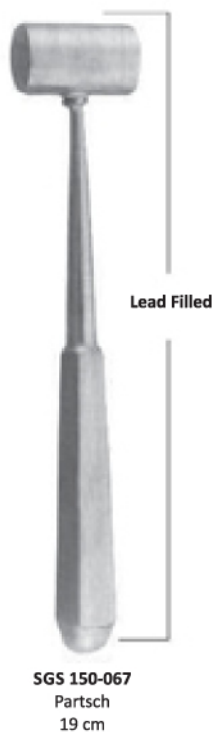
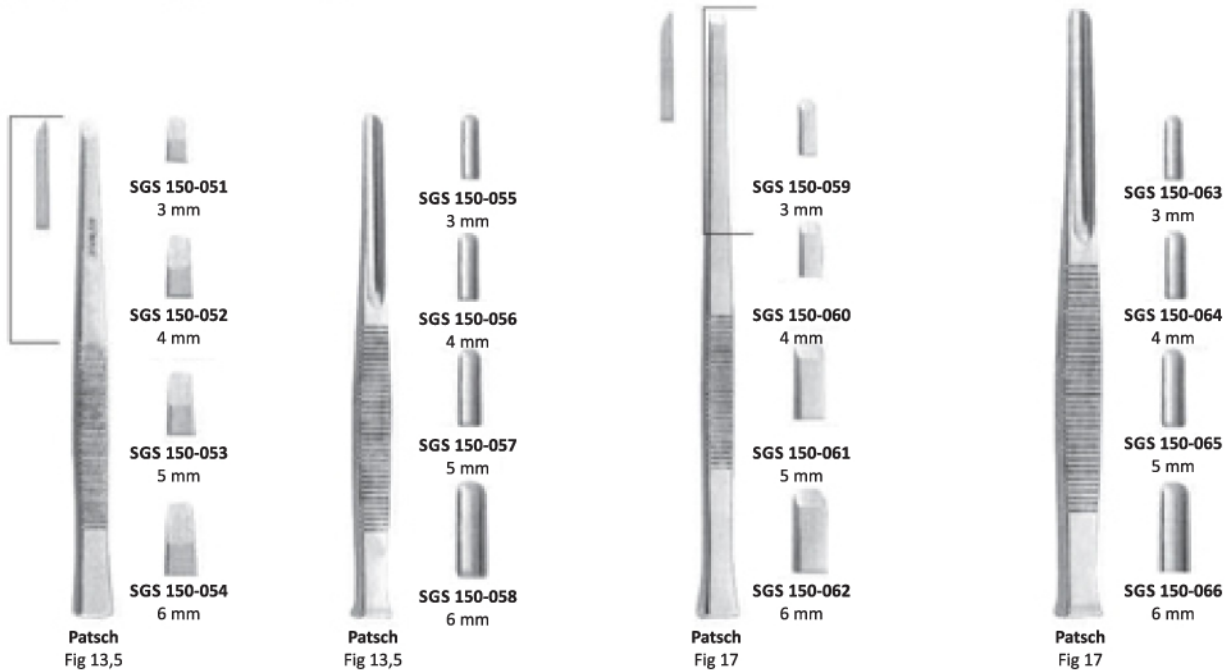



# **Dental Currettes**



## 160 Gracey Curettes

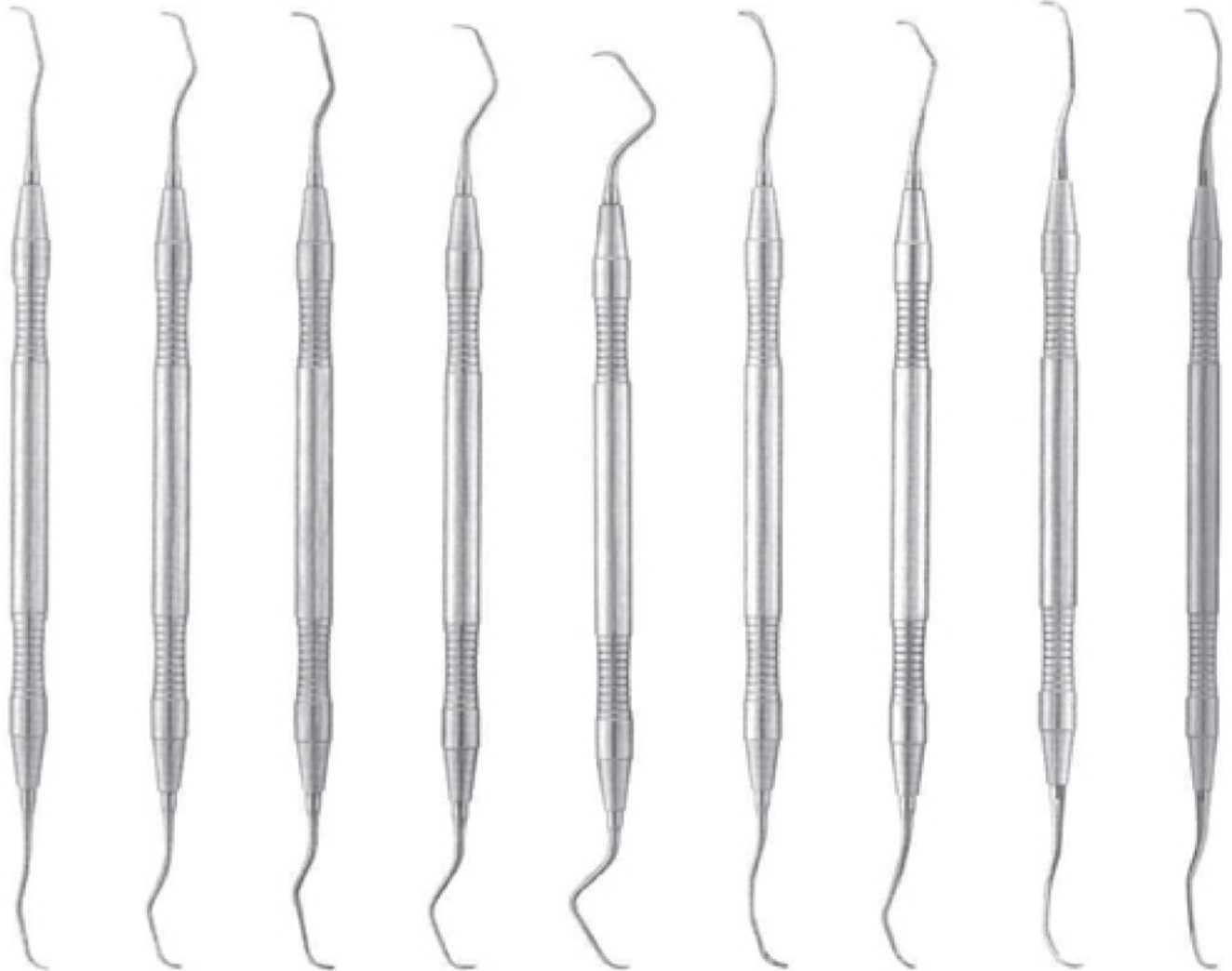
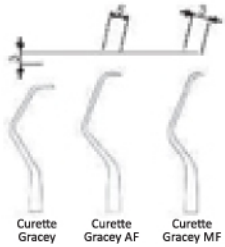

<b>SGS 160-001</b> Gracey 1/4	<b>SGS 160-002</b> Gracey 3/4	<b>SGS 160-003</b> Gracey 5/6	<b>SGS 160-004</b> Gracey 7/8	<b>SGS 160-005</b> Gracey 9/10	<b>SGS 160-006</b> Gracey 11/12	<b>SGS 160-007</b> Gracey 13/14	<b>SGS 160-008</b> Gracey Mesial Distal 11/14	<b>SGS 160-009</b> Gracey Mesial Distal 12/13
-------------------------------------	-------------------------------------	-------------------------------------	-------------------------------------	--------------------------------------	---------------------------------------	---------------------------------------	--	--



## 160 Gracey Curettes AF Type

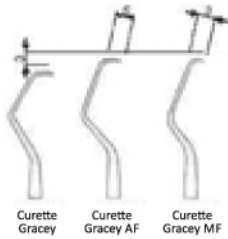

**SGS 160-010**  
Gracey  
AF/Type  
Fig 1/2



**SGS 160-011**  
Gracey  
AF/Type  
Fig 3/4



**SGS 160-012**  
Gracey  
AF/Type  
Fig 5/6



**SGS 160-013**  
Gracey  
AF/Type  
Fig 7/8



**SGS 160-014**  
Gracey  
AF/Type  
Fig 11/12



**SGS 160-015**  
Gracey  
AF/Type  
Fig 13/14



**SGS 160-016**  
Gracey  
AF/Type  
Fig 15/16



## 160 Gracey Curettes, AF, MF Type



<b>SGS 160-018</b> Gracey AF/Type Fig 1/2	<b>SGS 160-019</b> Gracey AF/Type Fig 3/4	<b>SGS 160-020</b> Gracey AF/Type Fig 5/6	<b>SGS 160-021</b> Gracey AF/Type Fig 7/8	<b>SGS 160-022</b> Gracey AF/Type Fig 11/12	<b>SGS 160-023</b> Gracey AF/Type Fig 13/14	<b>SGS 160-024</b> Gracey AF/Type Fig 15/16
--	--	--	--	--	--	--

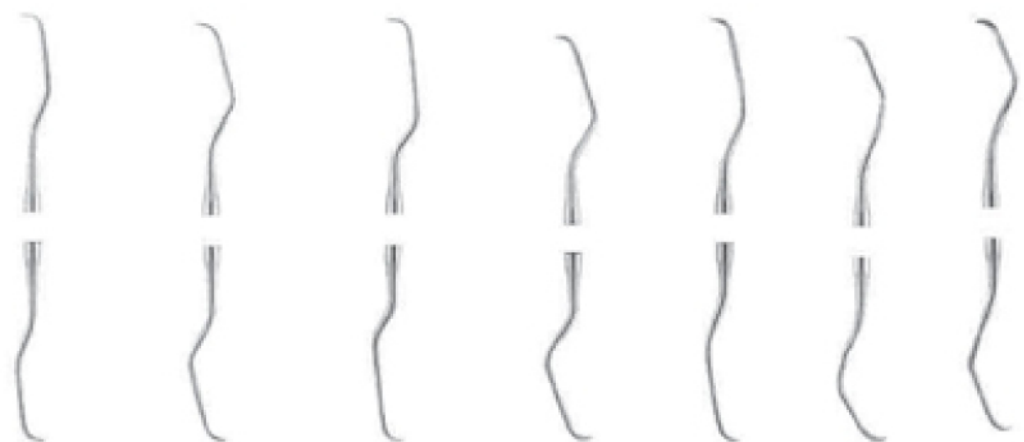

<b>SGS 160-017</b> Gracey AF/Type	<b>SGS 160-025</b> Gracey MF/Type Fig 1/2	<b>SGS 160-026</b> Gracey MF/Type Fig 3/4	<b>SGS 160-027</b> Gracey MF/Type Fig 5/6	<b>SGS 160-028</b> Gracey MF/Type Fig 7/8	<b>SGS 160-029</b> Gracey MF/Type Fig 11/12	<b>SGS 160-030</b> Gracey MF/Type Fig 13/14	<b>SGS 160-031</b> Gracey MF/Type Fig 15/16
---	--	--	--	--	--	--	--



## 160 Curettes Gracey MF Type

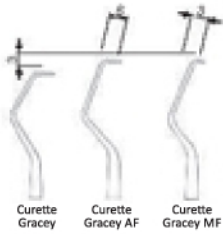

**SGS 160-032**  
Gracey  
MF/Type  
Fig 1/2



**SGS 160-033**  
Gracey  
MF/Type  
Fig 3/4



**SGS 160-034**  
Gracey  
MF/Type  
Fig 5/6



**SGS 160-035**  
Gracey  
MF/Type  
Fig 7/8



**SGS 160-036**  
Gracey  
MF/Type  
Fig 11/12

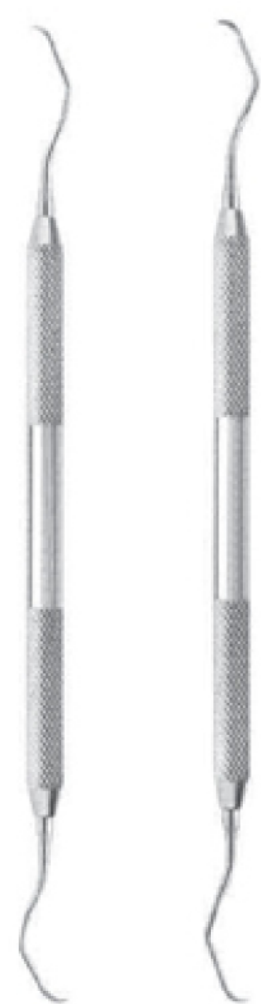

**SGS 160-037**  
Gracey  
MF/Type  
Fig 13/14



**SGS 160-038**  
Gracey  
MF/Type  
Fig 15/16



## 160 Curettes and Scalers



**SGS 160-039**  
Goldman - Fax  
Fig 1



**SGS 160-040**  
Goldman - Fax  
Fig 2



**SGS 160-041**  
Goldman - Fax  
Fig 3



**SGS 160-042**  
Goldman - Fax  
Fig 4



**SGS 160-043**  
Goldman - Fax  
Fig 21



**SGS 160-044**  
Goldman - Fax  
Fig 5



**SGS 160-045**  
MC Call  
Fig 13S/14S



**SGS 160-046**  
Younger Good  
Fig 7/8



## 160 Curettes and Scalers

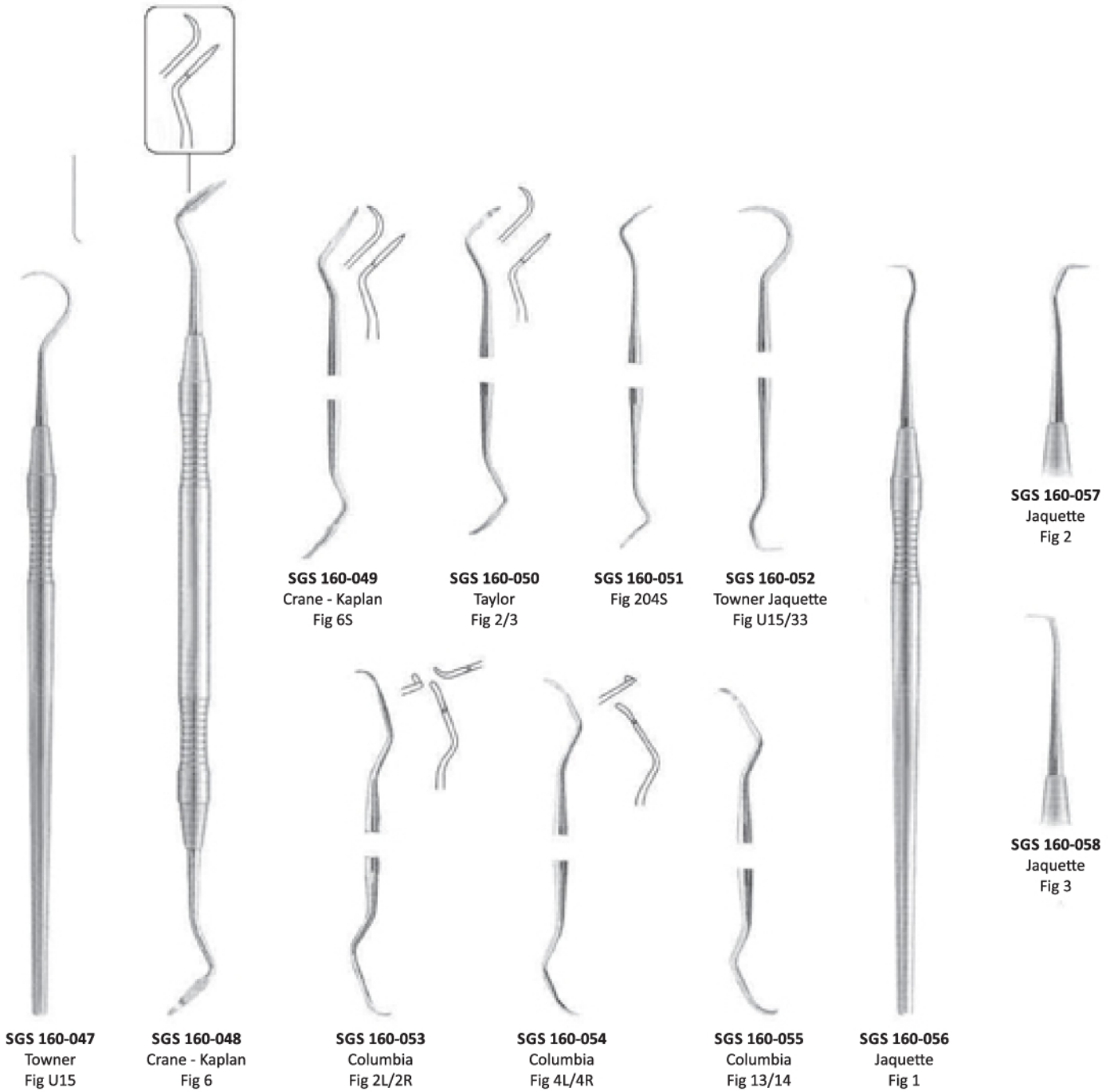



## 160 Bone Curette



**SGS 160-059**  
Hemingway  
Fig 1



**SGS 160-060**  
Hemingway  
Fig 2



**SGS 160-061**  
Hemingway  
Fig 3



**SGS 160-062**  
Lucas  
Fig 85



**SGS 160-063**  
Lucas  
Fig 86



**SGS 160-064**  
Lucas  
Fig 87



# **Modelling Instruments**



## 170 Modelling Instruments

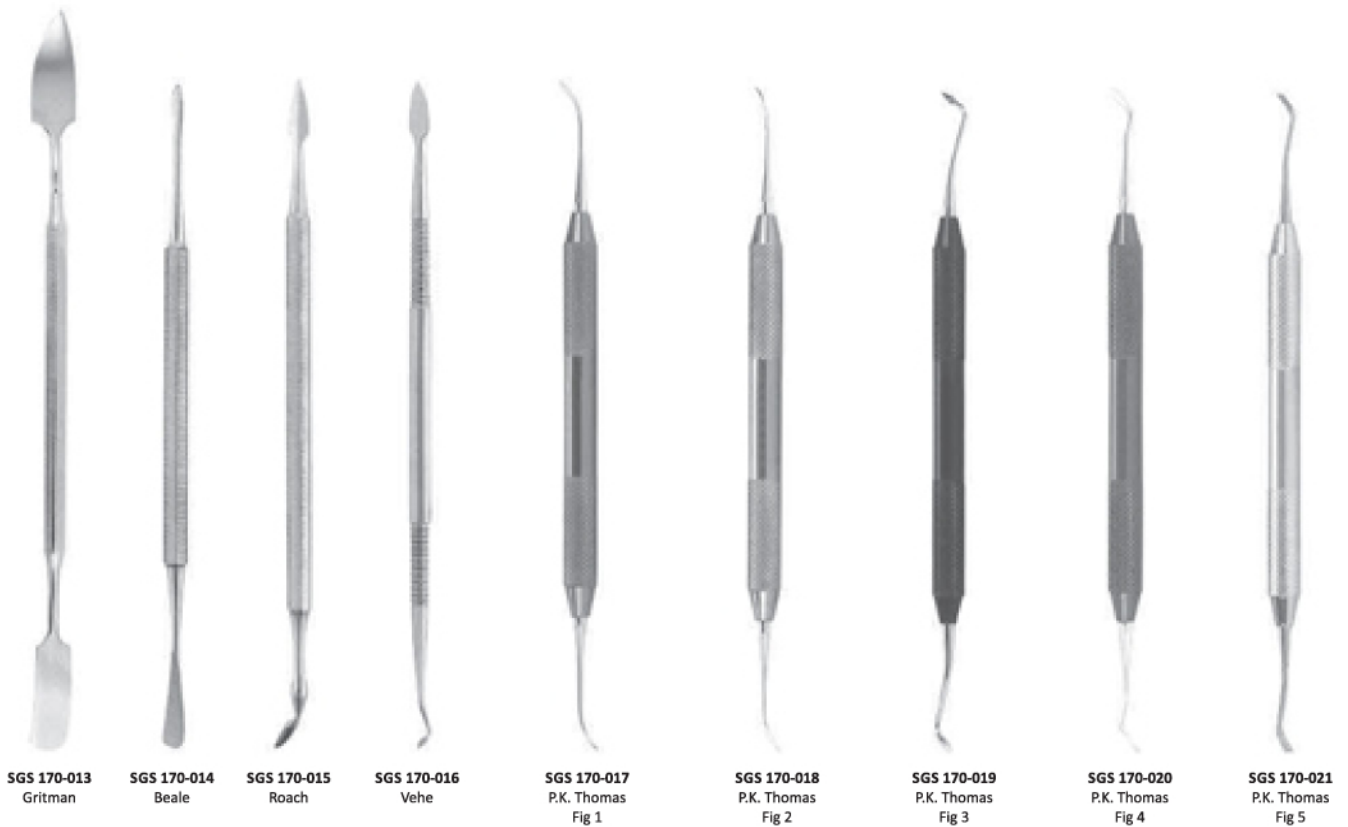
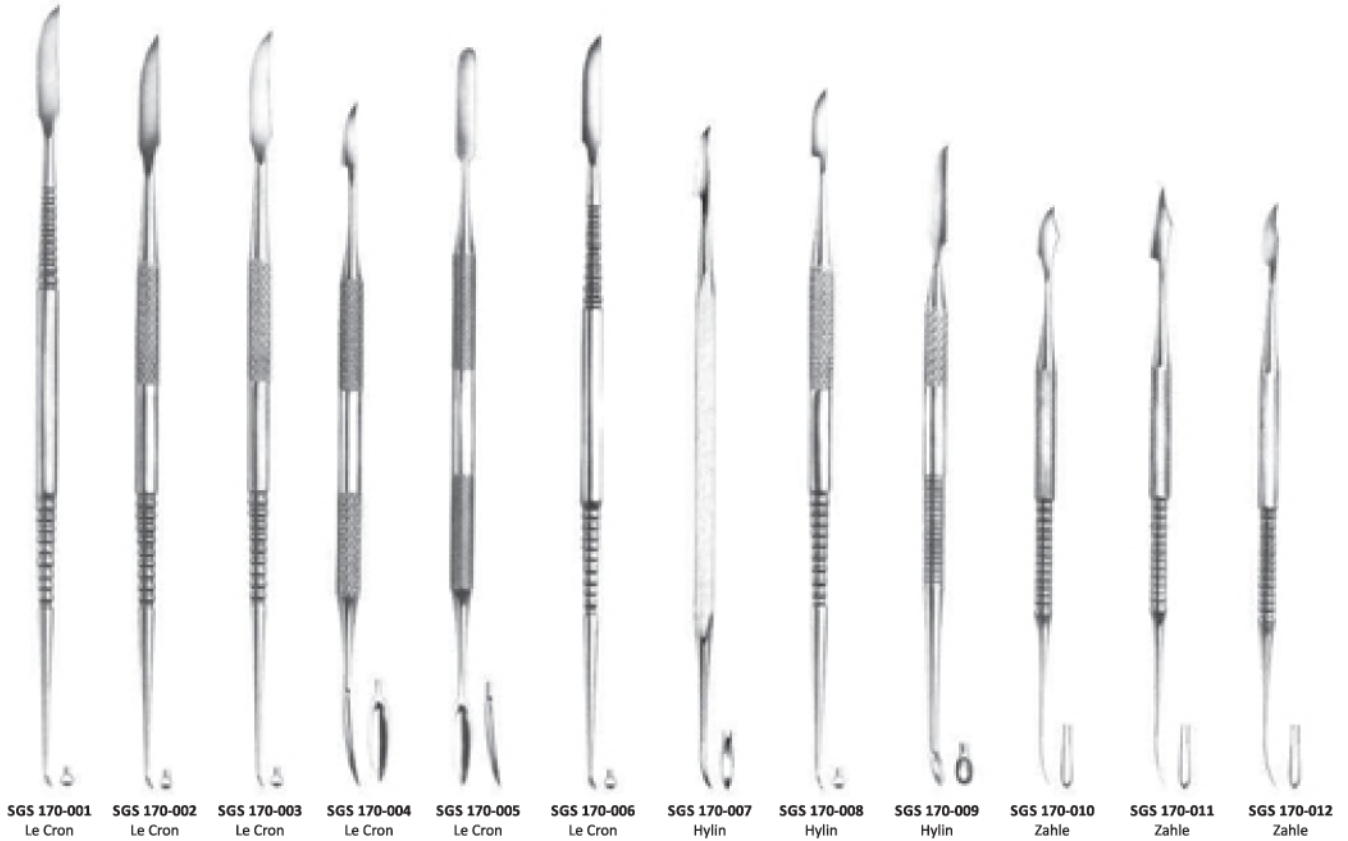



## 170 Modelling Instruments



**SGS 170-022**  
18 cm  
Fig 7 1/4"



**SGS 170-023**  
18 cm  
Fig 7 1/4"



**SGS 170-024**  
17 cm  
Fig 6 1/2"  
Gritman



**SGS 170-025**  
17 cm  
Fig 6 1/2"  
Medicon



**SGS 170-026**  
22 cm  
8 3/4"



**SGS 170-027**  
Antkoviak



**SGS 170-028**  
Emert



**SGS 170-029**  
Emert

# Measuring Instruments



## 170 Measuring Instruments



**SGS 170-001**  
Boley



**SGS 170-002**  
Zuricher  
130 mm



**SGS 170-003**  
Vernier  
12 cm



**SGS 170-004**  
Vernier

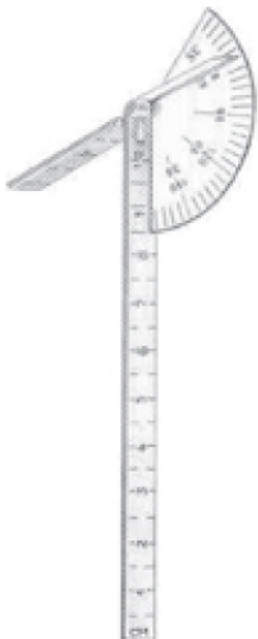

**SGS 170-005**  
Caroll



**SGS 170-006**  
Castroviejo's  
Scleral Markers



**SGS 170-007**  
Iwanson

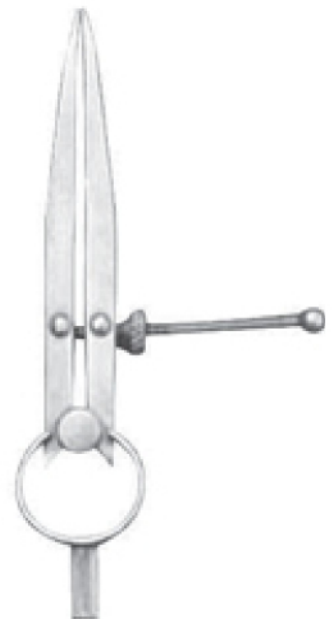

**SGS 170-008**  
Albee

**Knives**



**SGS 180-001**  
Fahnenstock  
Fig 1  
12,5 cm



**SGS 180-002**  
Fahnenstock  
Fig 2  
17 cm



**SGS 180-003**  
Lessmann  
Fig 1  
12,5 cm



**SGS 180-004**  
Lessmann  
Fig 2  
17 cm



**SGS 180-005**  
Con scodellin  
Fig 1  
12,5 cm



**SGS 180-006**  
Con scodellin  
Fig 2  
17 cm



**SGS 180-007**  
Fig 1  
17 cm



**SGS 180-008**  
Gritman  
Fig 2  
17 cm



**SGS 180-009**  
Fig 3  
16 cm



**SGS 180-010**  
Fig 4  
16 cm



# **Diagnostics**



### Explorers



SGS 190-001  
Fig 23



SGS 190-002  
Fig 6



SGS 190-003  
Fig 8



SGS 190-004  
Fig 9



SGS 190-005  
Fig 17



SGS 190-006  
Fig 3  
Rein



SGS 190-007  
Fig 23/17



SGS 190-008  
Fig 17

# **Endodontic Instruments**



## 200 Endodontic Instruments



**SGS 200-001**  
Fig 1  
Spreader

**SGS 200-002**  
Fig 2  
Spreader

**SGS 200-003**  
Fig 3  
Spreader

**SGS 200-004**  
Fig 4  
Spreader

**SGS 200-005**  
Fig 5  
Spreader

**SGS 200-006**  
Fig 6  
Spreader

**SGS 200-007**  
Fig 7  
Spreader



## 200 Endodontic Instruments

Double-Ended Root Canal  
Explorers Plugger/Spreaders

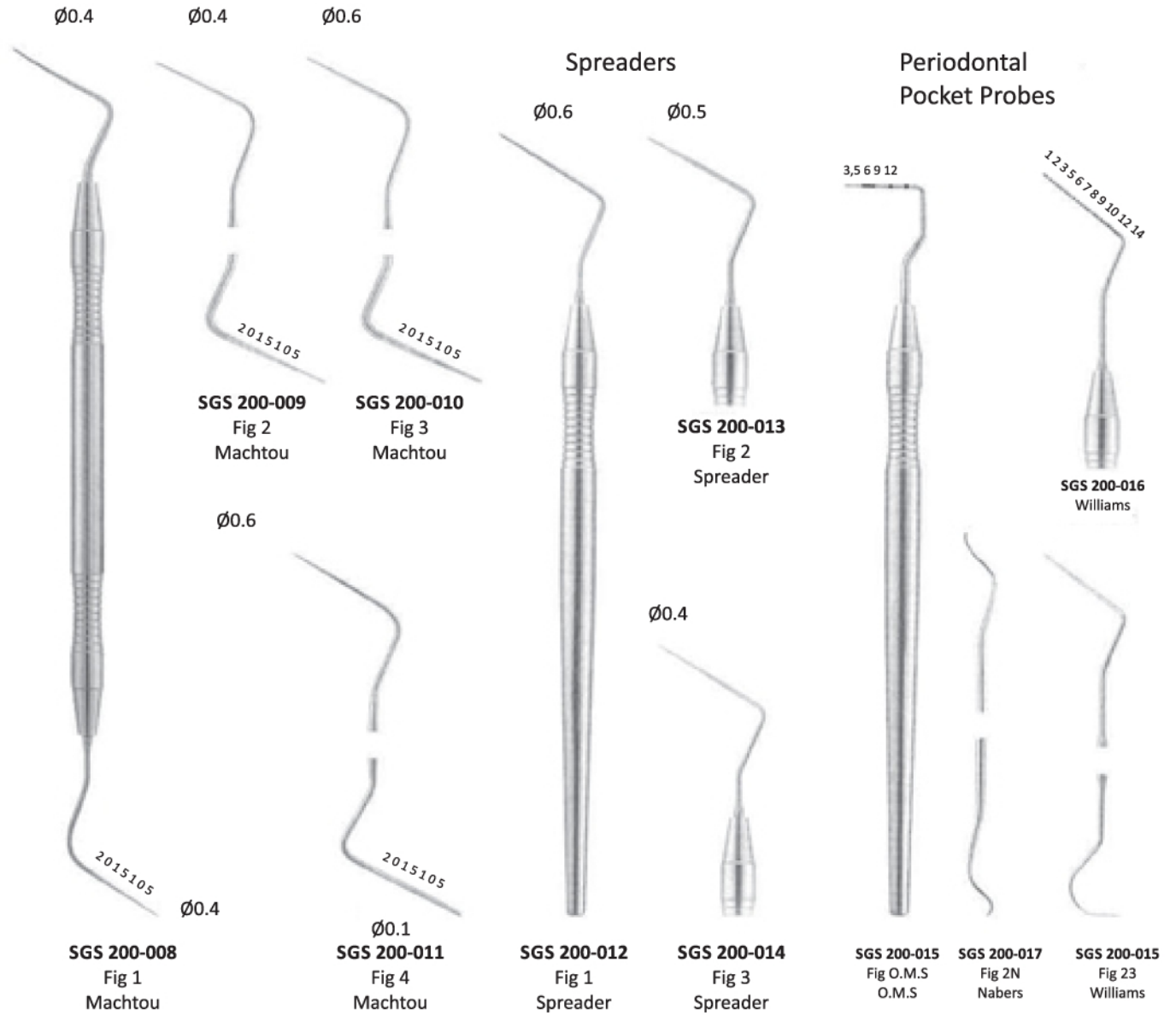



## 200 Endodontic Instruments

### Root Canal Pluggers

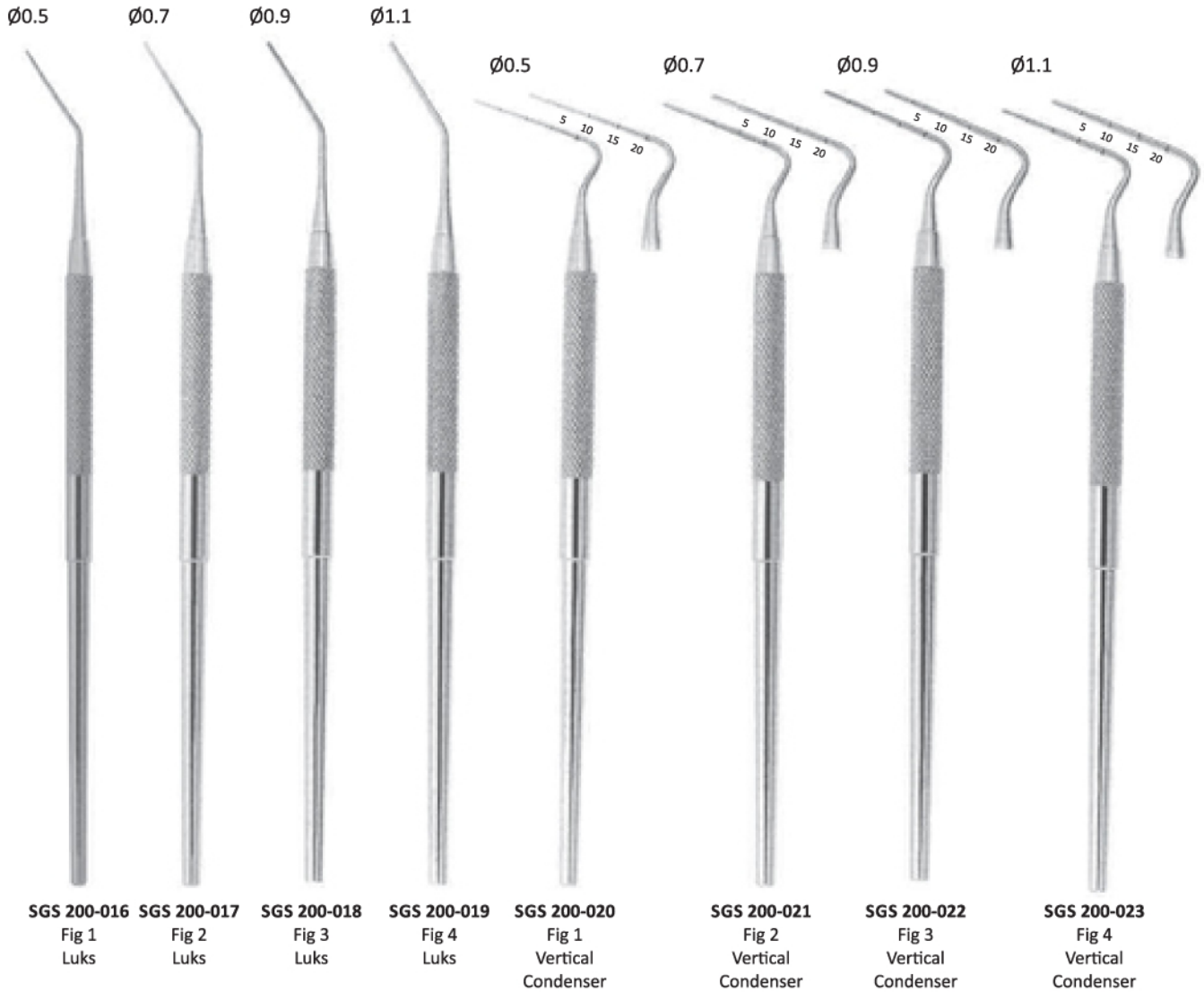

Endodontic Set





## 200 Endodontic Instruments

### Root Canal Pluggers

Optimum Flexibility  
Very Fine Points

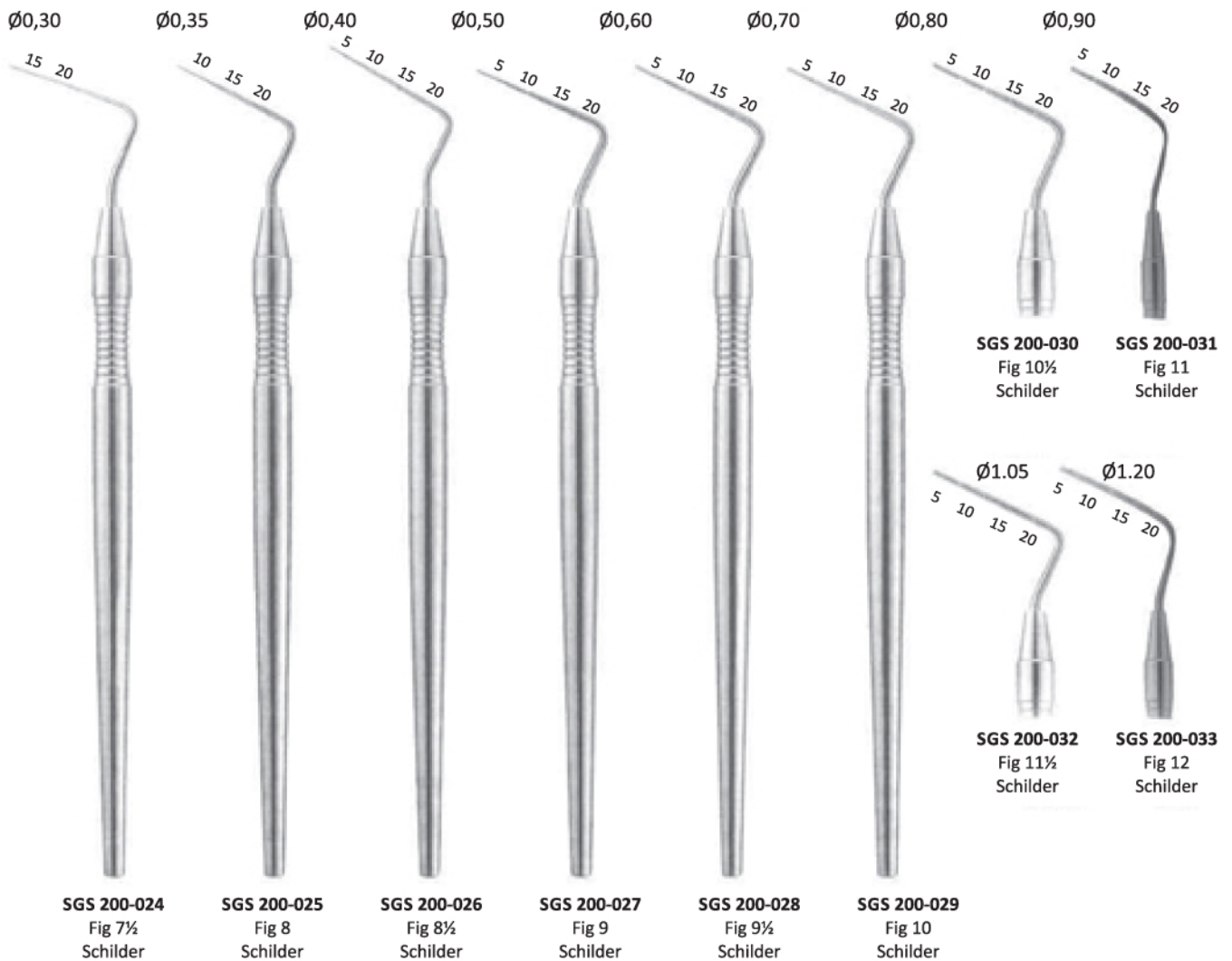



## 200 Endodontic Instruments

### Root Canal Explorers



SGS 200-034  
Fig 6/1

SGS 200-035  
Fig 6/17

SGS 200-036  
Fig 6/23

### Root Canal Excavators



SGS 200-037  
Fig 31 L

SGS 200-038  
Fig 32 L

SGS 200-039  
Fig 33 L



# Excavators



## 210 Excavators

1 mm



SGS 210-001  
Fig 5

1.2 mm



SGS 210-002  
Fig 14

1 mm



SGS 210-003  
Fig 17

1.2 mm



SGS 210-004  
Fig 18

1.6 mm



SGS 210-005  
Fig 19

2 mm



SGS 210-006  
Fig 20



## 210 Excavators

1 mm



**SGS 210-007**  
ASH  
Fig 243

1,4 mm



**SGS 210-008**  
ASH  
Fig G2

0,8 mm



**SGS 210-009**  
Fig 1

0,8 mm



**SGS 210-010**  
Fig 2

1 mm



**SGS 210-011**  
Fig 11

1 mm



**SGS 210-012**  
Fig 12

1,2 mm



**SGS 210-013**  
Fig 21

1,2 mm



**SGS 210-014**  
Fig 22

1,6 mm



**SGS 210-015**  
Fig 31

1,6 mm



**SGS 210-016**  
Fig 32

2 mm



**SGS 210-017**  
Fig 41

2 mm



**SGS 210-018**  
Fig 42

# **Mouth Mirrors & Handles**



## 220 Mouth Mirrors and Handles

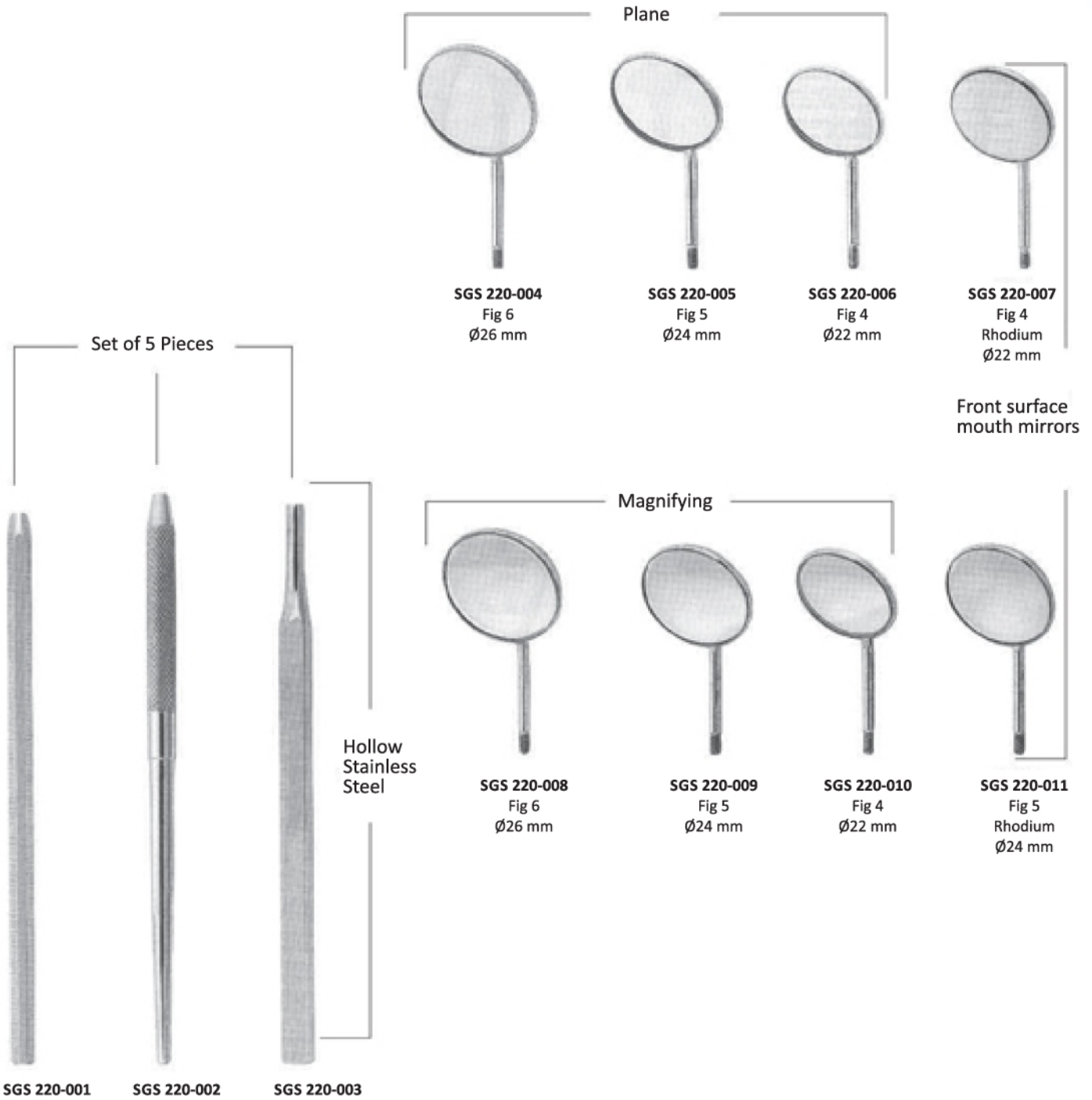



## 220 Mouth Mirrors and Handles



SGS 220-012



SGS 220-013



SGS 220-014



SGS 220-015



SGS 220-016



SGS 220-017  
Parallelometer  
mouth mirror

SGS 220-018  
Parallelometer  
mouth mirror  
+handle  
code 2101

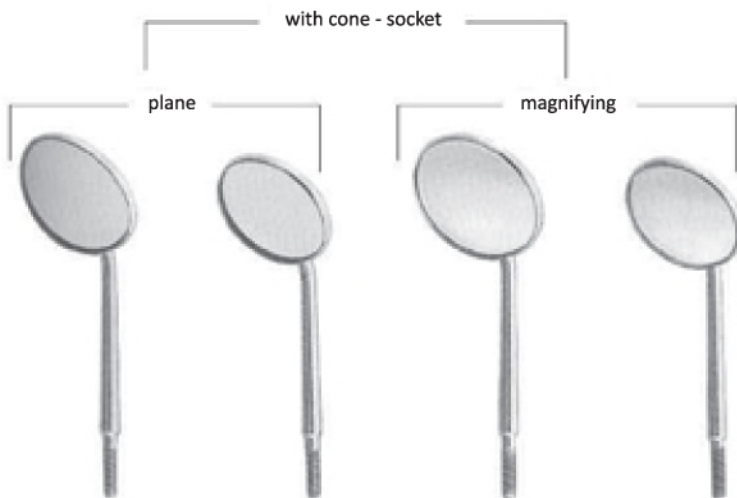

SGS 220-019  
Fig 5  
Ø24 mm

SGS 220-020  
Fig 4  
Ø22 mm

SGS 220-021  
Fig 5  
Ø24 mm

SGS 220-022  
Fig 4  
Ø22 mm



SGS 220-023  
cone - socket



SGS 220-024  
cone - socket



SGS 220-025  
cone - socket

**Spatulas**



## 230

## Cement Spatulas



SGS 230-001



SGS 230-002



SGS 230-003



SGS 230-004



SGS 230-005



SGS 230-006



SGS 230-007



SGS 230-008





## 230

## Cement Spatulas

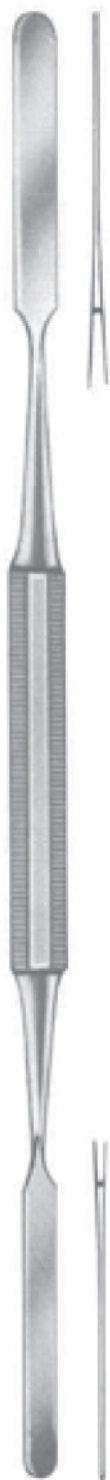

SGS 230-009

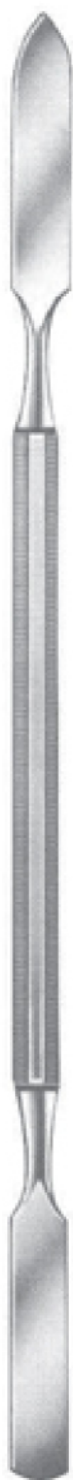

SGS 230-010



SGS 230-011



SGS 230-012



SGS 230-013



SGS 230-014



SGS 230-015



SGS 230-016



SGS 230-017



SGS 230-018



SGS 230-019



SGS 230-020



## 230 Spatulas for Plaster and Alginate

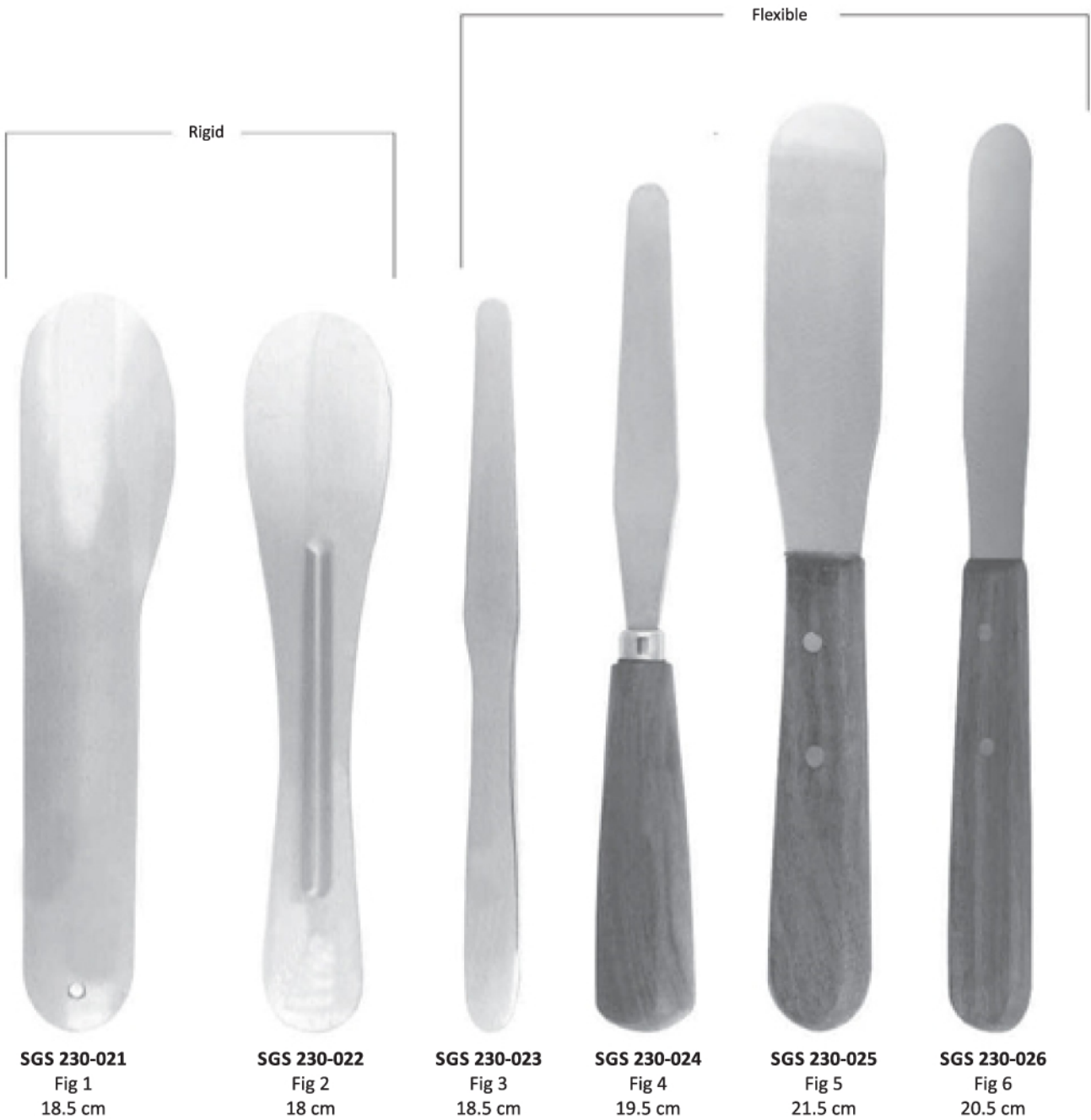



## 230 Spatulas for Plaster and Alginate

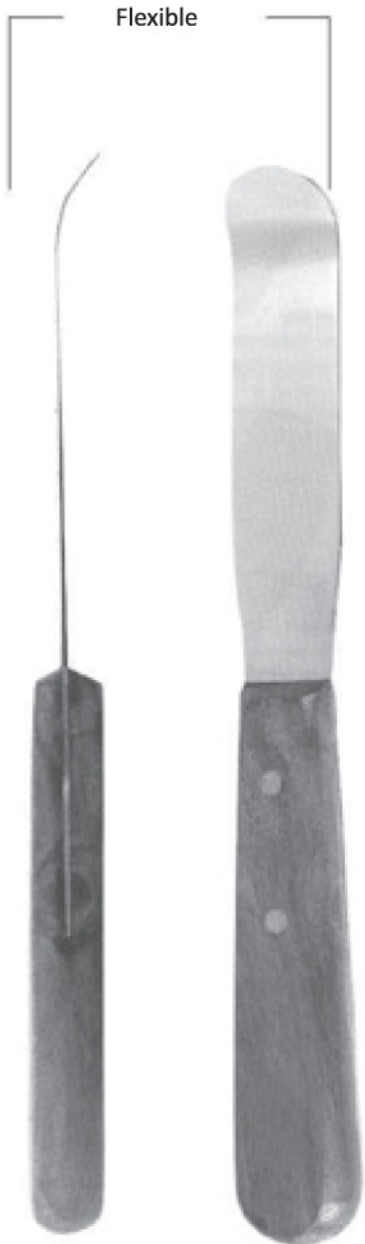

SGS 230-027

Fig 7  
19.5 cm



SGS 230-028

Fig 8  
20 cm

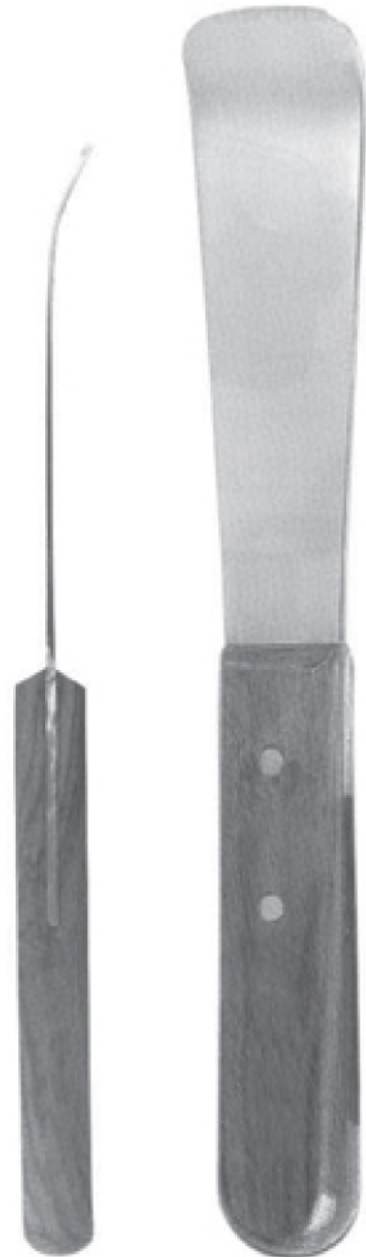

SGS 230-029

Fig 9  
22.5 cm

# **Needle Holders**



## 240 Needle Holders



**SGS 240-001**  
Mayo Hegar  
16 cm

**SGS 240-002**  
Mayo Hegar TC  
16 cm

**SGS 240-003**  
Mayo Hegar  
18 cm

**SGS 240-004**  
Mayo Hegar TC  
18 cm



**SGS 240-005**  
Mini-Ryder  
18 cm

**SGS 240-006**  
Mini-Ryder  
15 cm

**SGS 240-007**  
Derf  
12 cm

**SGS 240-008**  
Hegar-Baumgarther  
14 cm



## 240 Needle Holders



**SGS 240-009**  
Crile-Wood  
15 cm



**SGS 240-010**  
Crile-Wood TC  
15 cm



**SGS 240-011**  
Adson  
17.5 cm



**SGS 240-012**  
Olsen-Hegar  
14 cm



**SGS 240-013**  
Baumgarther  
14.5 cm



**SGS 240-014**  
Gillies  
16 cm



**SGS 240-015**  
Gillies  
16 cm



**SGS 240-016**  
Hegar-Baumgarther  
14 cm



## 240 Needle Holders



**SGS 240-017**  
Toennis  
18 cm



**SGS 240-018**  
Toennis  
18 cm



**SGS 240-019**  
Lichtenberg  
17 cm



**SGS 240-020**  
Lichtenberg  
17 cm



**SGS 240-021**  
Eiselberg-Mathieu  
19.5 cm



**SGS 240-022**  
Boyton  
12 cm



**SGS 240-023**  
Arruga  
16 cm



**SGS 240-024**  
Boyton  
12 cm



**SGS 240-025**  
Arruga  
16 cm



## 240 Needle Holders



**SGS 240-026**  
Castroviejo  
14 cm



**SGS 240-027**  
Castroviejo  
14 cm



**SGS 240-028**  
Castroviejo  
14/60 cm



**SGS 240-029**  
Castroviejo  
18 cm



**SGS 240-030**  
Castroviejo  
18 cm



**SGS 240-031**  
Castroviejo  
14 cm

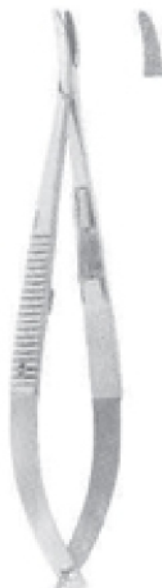

**SGS 240-032**  
Castroviejo  
14 cm



**SGS 240-033**  
Castroviejo  
14/60 cm



**SGS 240-034**  
Castroviejo  
18 cm



**SGS 240-035**  
Castroviejo  
18 cm





**240**

## Needle Holders



**SGS 240-036**  
Mathieu  
14 cm



**SGS 240-037**  
Mathieu  
14 cm



**SGS 240-038**  
Mathieu  
14 cm



**SGS 240-039**  
Mathieu  
14 cm



**SGS 240-040**  
Mathieu  
17 cm



**SGS 240-041**  
Mathieu  
17 cm



**SGS 240-042**  
Mathieu  
14 cm



**SGS 240-043**  
Mathieu  
18 cm



## 240 Needle Holders



The tips have tungsten carbide inserts for better handling



**SGS 240-044**  
Mathieu  
17 cm



**SGS 240-045**  
Mathieu  
17 cm



**SGS 240-046**  
Micro-Barraquer  
14 cm



**SGS 240-047**  
Castroviejo  
13 cm



**SGS 240-048**  
Castroviejo-Barraquer  
13 cm



**SGS 240-049**  
Castroviejo  
13 cm



**SGS 240-050**  
Castroviejo  
13 cm



**SGS 240-052**  
18.03 cm



**SGS 240-053**  
18.04 cm



**SGS 240-054**  
18.05 cm



**SGS 240-051**  
Fig 6FR  
Fraizer  
15.02 mm, cm



**SGS 240-055**  
Fig 12FR  
Fraizer  
15.04mm, cm

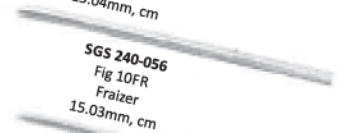

**SGS 240-056**  
Fig 10FR  
Fraizer  
15.03mm, cm



**SGS 240-057**  
Fig 8FR  
Fraizer  
15.02mm, cm

# **Dental Syringes**



## 250 Water Syringes



**SGS 250-001**  
Water syringe complete with  
1 cannula (Lure-Lock)



**SGS 250-002**  
Water syringe complete with  
1 cannula (Lure-Lock)



**SGS 250-003**  
Metal Water syringe, Self-gilling  
1 cannula (Lure-Lock)



**SGS 250-004**  
Sparrel Barrel with  
plugger suitable  
for syringes



**SGS 250-005**  
Cannula only,  
with lure-lock  
connector suitable  
for syringes



**250** Syringes, Rulers, Band Adaptor, Position Guage



**SGS 250-006**  
Aspirating  
Syringe



**SGS 250-007**  
Position Guage

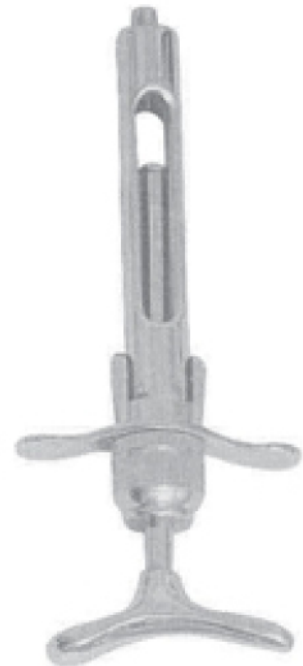

**SGS 250-008**  
Breach Loading  
Syringe



**SGS 250-009**  
Aspirating & Breach  
Syringe



**SGS 250-010**  
Band adaptor



**SGS 250-011**  
Endo Figure Ruler  
with adjustable slide

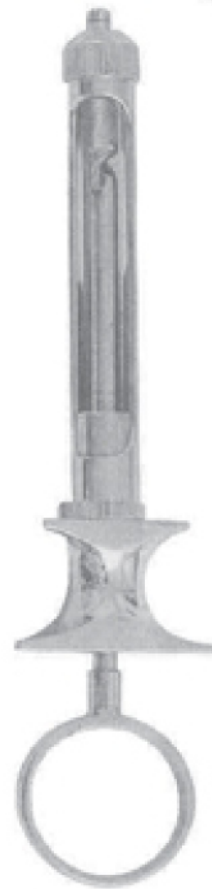

**SGS 250-012**  
Aspirating Syringe



## 250 Syringes, Rulers, Band Adaptor, Position Guage



SGS 250-013



SGS 250-014



SGS 250-015



SGS 250-016 1,8 ml  
SGS 250-017 2,2 ml  
Cartridge Syringe complete  
with 2 tips and without needles



SGS 250-018  
Tip only, short



SGS 250-019  
Tip only, long



SGS 250-020



SGS 250-021



SGS 250-022



## 250 Syringes, Rulers, Band Adaptor, Position Guage



**SGS 250-023**  
Cork screw tip



**SGS 250-024**  
Cork screw tip



**SGS 250-025**  
folding type,  
cork screw tip



**SGS 250-026**  
folding type,  
cork screw tip



**SGS 250-027**



**SGS 250-028**  
cork screw tip

**SGS 250-029**  
spare cap with  
metric thread

**SGS 250-030**  
with without  
thread

**SGS 250-031**  
Autoclavable plastic protection sleeve



**SGS 250-032**  
Brass syringe with stainless steel moving parts



**SGS 250-033**  
Brass syringe with  
stainless steel moving parts

# **Dental Tweezers**





## 250 Dental Tweezers



**SGS 250-034**  
College  
15 cm



Smooth



**SGS 250-035**  
College  
15 cm



Serrated



**SGS 250-036**  
College  
15 cm



Smooth



**SGS 250-037**  
College  
15 cm



Serrated



**SGS 250-038**  
College  
15 cm



Smooth



**SGS 250-039**  
College  
15 cm

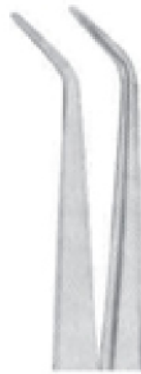

Serrated



**SGS 250-040**  
College  
15 cm



Smooth



**SGS 250-041**  
College  
15 cm



Serrated



## 250 Dental Tweezers



**SGS 250-042**  
Meriam  
16 cm



Smooth



**SGS 250-043**  
Meriam  
16 cm



Serrated



**SGS 250-044**  
Meriam  
16 cm



Smooth



**SGS 250-045**  
Meriam  
16 cm



Serrated



**SGS 250-046**  
Meriam  
16 cm



Smooth



**SGS 250-047**  
Meriam  
16 cm



Serrated



**SGS 250-048**  
Meriam  
16 cm



Smooth



**SGS 250-049**  
Meriam  
16 cm



Serrated



## 250 Dental Tweezers

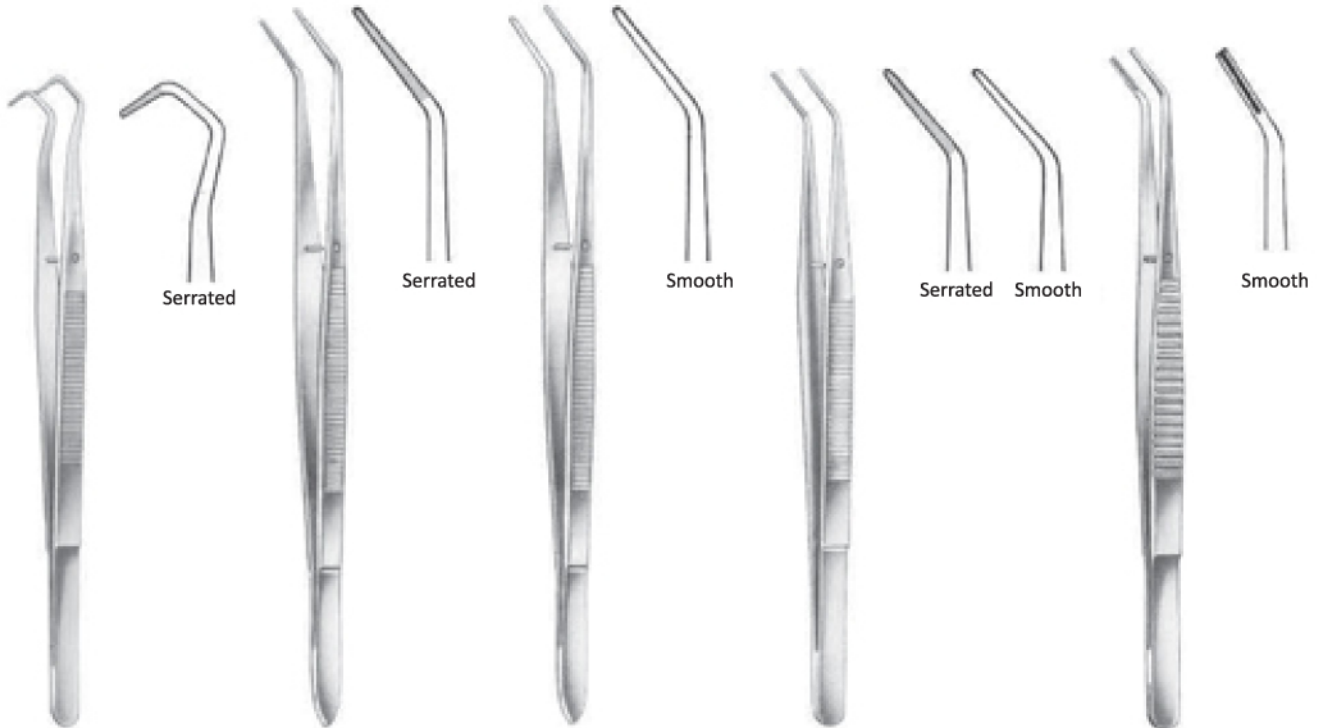

**SGS 250-050**  
College  
14.5 cm, 5 $\frac{3}{8}$ "

**SGS 250-051**  
Flagg  
16 cm, 6 $\frac{1}{4}$ "

**SGS 250-052**  
Flagg  
16 cm, 6 $\frac{1}{4}$ "

**SGS 250-053**  
Landgraf  
15 cm, 6"

**SGS 250-054**  
15.5 cm, 6 $\frac{1}{8}$ "

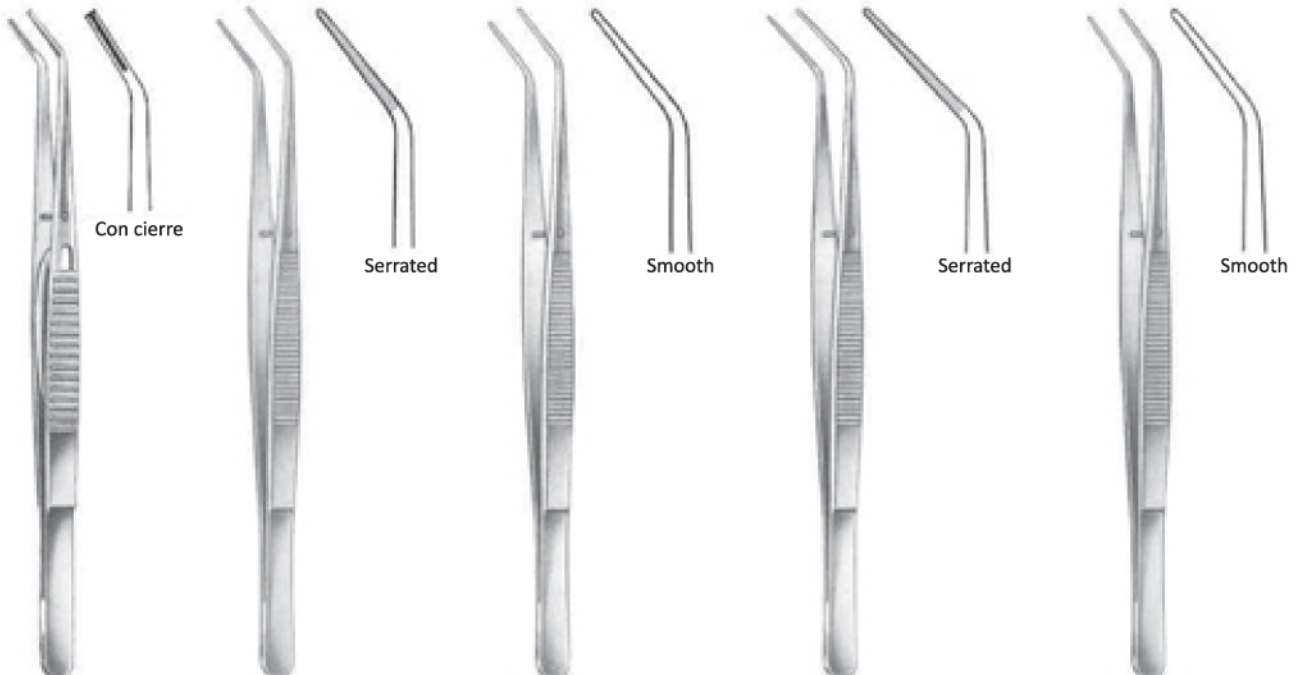

**SGS 250-055**  
15.5 cm, 6 $\frac{1}{8}$ "

**SGS 250-056**  
London College  
15 cm, 6"

**SGS 250-057**  
London College  
15 cm, 6"

**SGS 250-058**  
London College  
15 cm, 6"

**SGS 250-059**  
London College  
15 cm, 6"



**250**

## Dental Tweezers



**SGS 250-060**  
CK1  
15 cm, 6"

**SGS 250-061**  
CK1  
15 cm, 6"

**SGS 250-062**  
GF2  
16 cm, 6 1/4"

**SGS 250-063**  
GF1  
16 cm, 6 1/4"

**SGS 250-063**  
Kopp  
15.5 cm, 6 1/8"



**SGS 250-064**  
Kopp  
15.5 cm, 6 1/8"

**SGS 250-065**  
15 cm, 6"

**SGS 250-066**  
16.5 cm, 6 1/2"

**SGS 250-067**  
15.5 cm, 6 1/8"

**SGS 250-068**  
15.5 cm, 6 1/8"



**250**

**Dental Tweezers**



**SGS 250-069**  
London College  
15 cm, 6"



**SGS 250-070**  
London College  
15 cm, 6"

Con Cierre

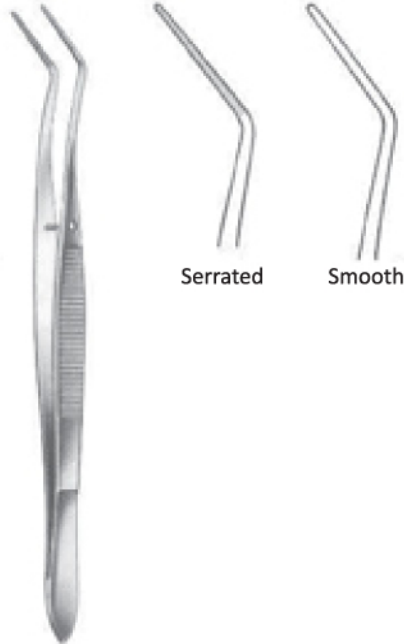

**SGS 250-071**  
Meriam  
16 cm, 6 1/4"

Serrated

Smooth

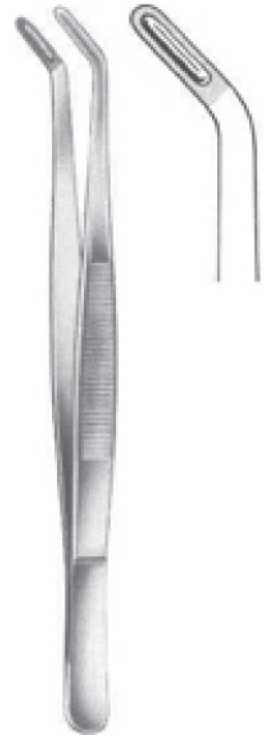

**SGS 250-072**  
Allen  
18 cm, 7 1/8"



**SGS 250-073**  
Albrecht  
16 cm, 6 1/4"



**SGS 250-074**  
Albrecht  
16 cm, 6 1/4"



**SGS 250-075**  
16 cm, 6 1/4"



**SGS 250-076**  
16 cm, 6 1/4"

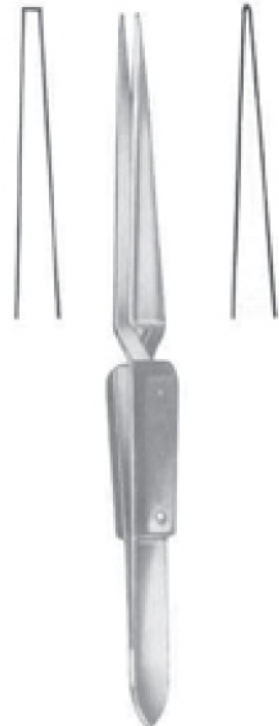

**SGS 250-077**  
16 cm, 6 1/4"

# **Rubber Dam Clamps**



## 260 Rubber Dam Clamp Forceps

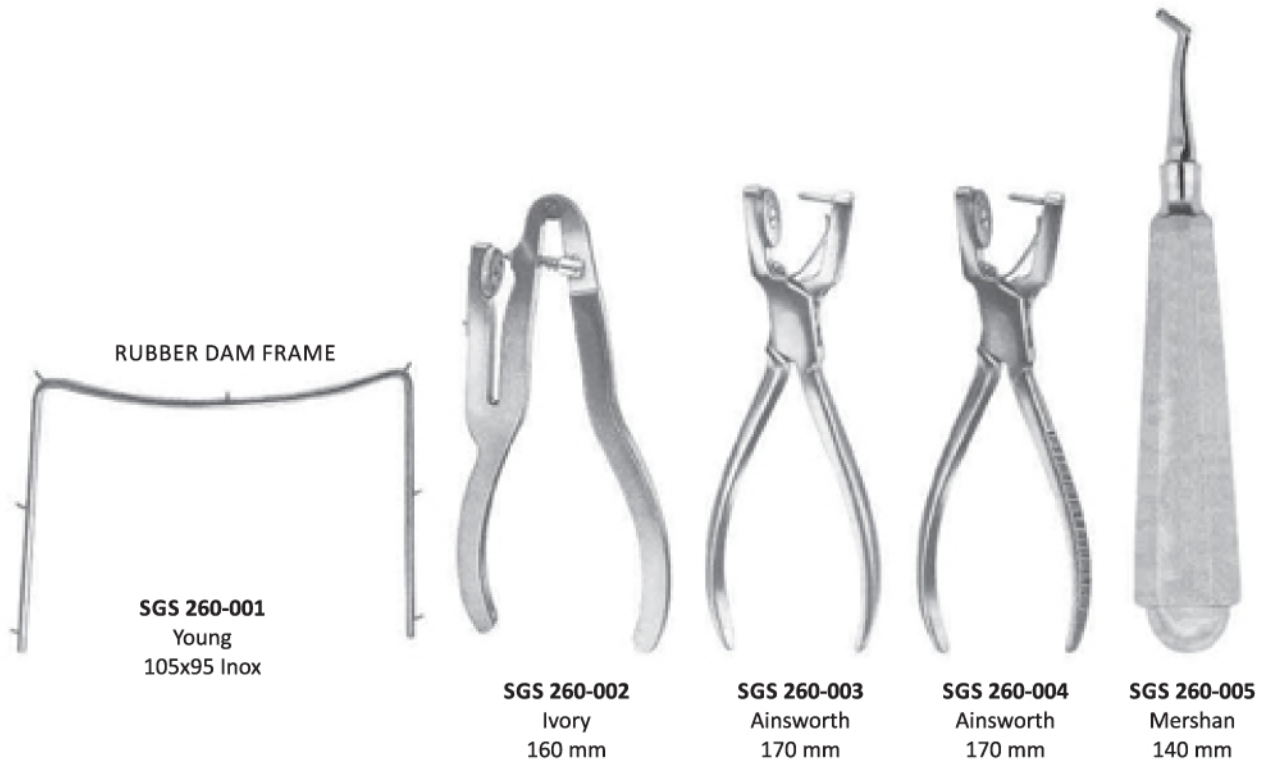

### CLAMPS (PLIERS)

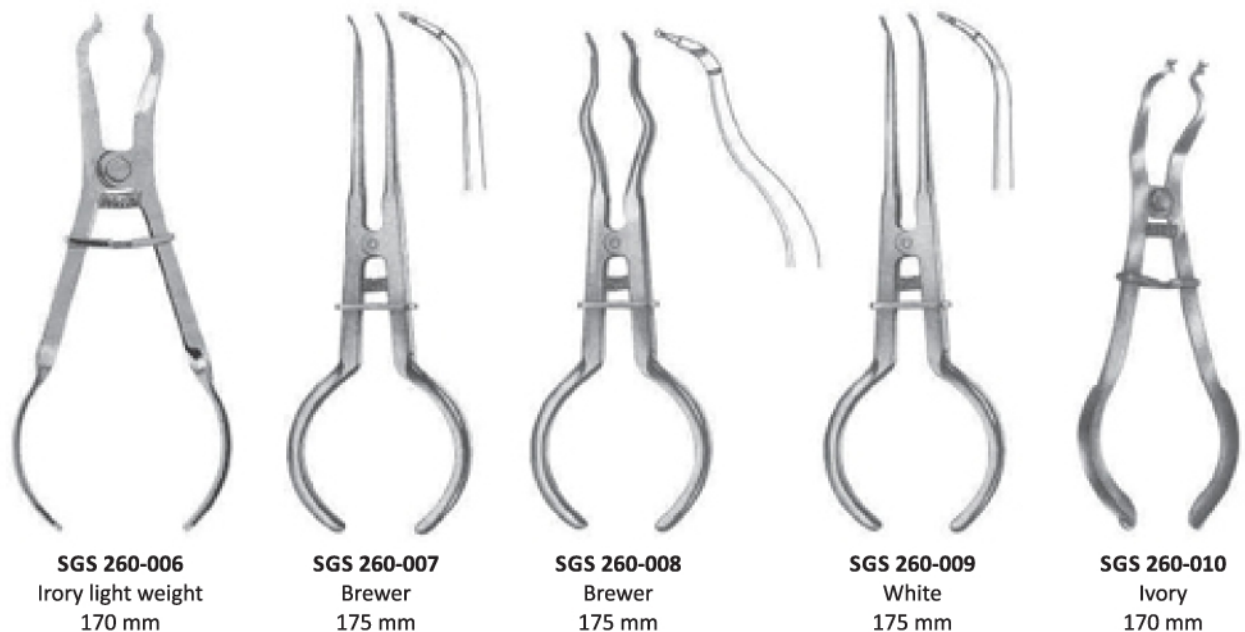



## 260 Rubber Dam Clamps

Anterior



**SGS 260-011**  
Winged  
Labial Clamp



**SGS 260-012**  
Winged Edged  
Labial Clamp



**SGS 260-013**  
Winged  
Cervical Clamp



**SGS 260-014**  
Winged  
Labial Clamp

Premolars



**SGS 260-015**  
Winged



**SGS 260-016**  
Winged



**SGS 260-017**  
Wingless

For small teeth, Elongated or with narrow collars



**SGS 260-018**  
Winged



**SGS 260-019**  
Winged



**SGS 260-020**  
Wingless

For general use with adjustable jaws according to gingival line shapes



**SGS 260-021**  
Winged



**SGS 260-022**  
Edged, Winged



**SGS 260-023**  
Wingless

For premolars, with Elongated Collars



**SGS 260-024**  
Winged



**SGS 260-025**  
Edged, Winged



**SGS 260-026**  
Wingless

For premolars, with Elongated Collars



**SGS 260-027**  
Winged



**SGS 260-028**  
Wingless





## 260 Rubber Dam Clamps



**SGS 260-029**  
Winged



**SGS 260-030**  
Wingless

For small lower molars



**SGS 260-031**  
Winged



**SGS 260-032**  
Wingless

For square lower molars



**SGS 260-033**  
Winged



**SGS 260-034**  
Wingless

For molar roots



**SGS 260-035**  
Winged



**SGS 260-036**  
Edged, Wingless



**SGS 260-037**  
Wingless

For round molars, partially broken, undersized or inclined



**SGS 260-038**  
Wingless



**SGS 260-039**  
Wingless



**SGS 260-040**  
Winged



**SGS 260-041**  
Winged

# **Matrix Retainers & Bands**



## 270 Matrix Retainers & Matrix Bands



**SGS 270-001**  
Ivory  
63mm

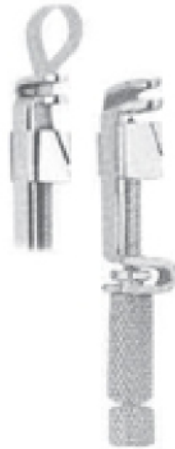

**SGS 270-002**  
Tofflemire, Universal



**SGS 270-003**  
Tofflemire, Junior



**SGS 270-004**  
Tofflemire, Senior



**SGS 270-005**  
Ivory 8  
5mm



**SGS 270-006**  
Ivory 8  
6mm



**SGS 270-007**  
Ivory 8  
7mm



**SGS 270-008**  
Ivory 8 N



**SGS 270-009**  
Didner 8 P



**SGS 270-011**



**SGS 270-012**



**SGS 270-013**



**SGS 270-014**

1750-5 mm x 100 cm  
1750-6 mm x 100 cm  
1750-7 mm x 100 cm



**SGS 270-010**

For Molars and Premolars



**SGS 270-015**



**SGS 270-016**



**SGS 270-017**



## 270 Matrix Bands



**SGS 270-018**  
Molar  
Fig 7



**SGS 270-019**  
Molar  
Fig 8



**SGS 270-020**  
Molar  
Fig 9



**SGS 270-021**  
Molar  
Fig 10



**SGS 270-022**  
Tofflemire



**SGS 270-023**  
Tofflemire



**SGS 270-024**  
Tofflemire



**SGS 270-025**  
Bicuspid



**SGS 270-026**  
Bicuspid



**SGS 270-027**  
Bicuspid



**SGS 270-028**  
Bicuspid



**SGS 270-029**  
Bicuspid

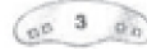

**SGS 270-030**  
Bicuspid



**SGS 270-034**



**SGS 270-031**  
Molar



**SGS 270-032**  
Molar



**SGS 270-033**  
Molar

# **Dental Crown Removers**



## 280 Dental Crown Removers

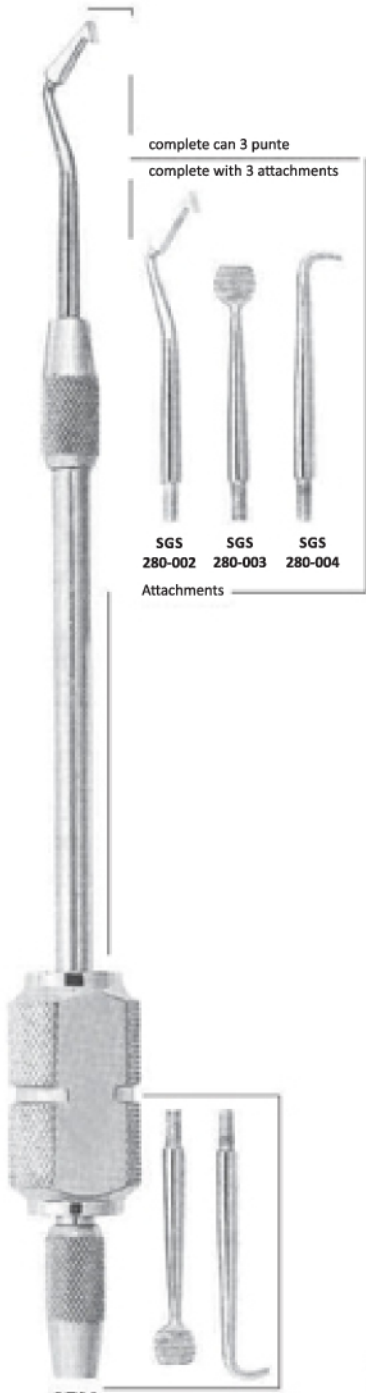

SGS 280-001



SGS 280-005  
Crown spreader, crown remove.  
special instrument for crown spreading  
after separating simple and safe  
operation

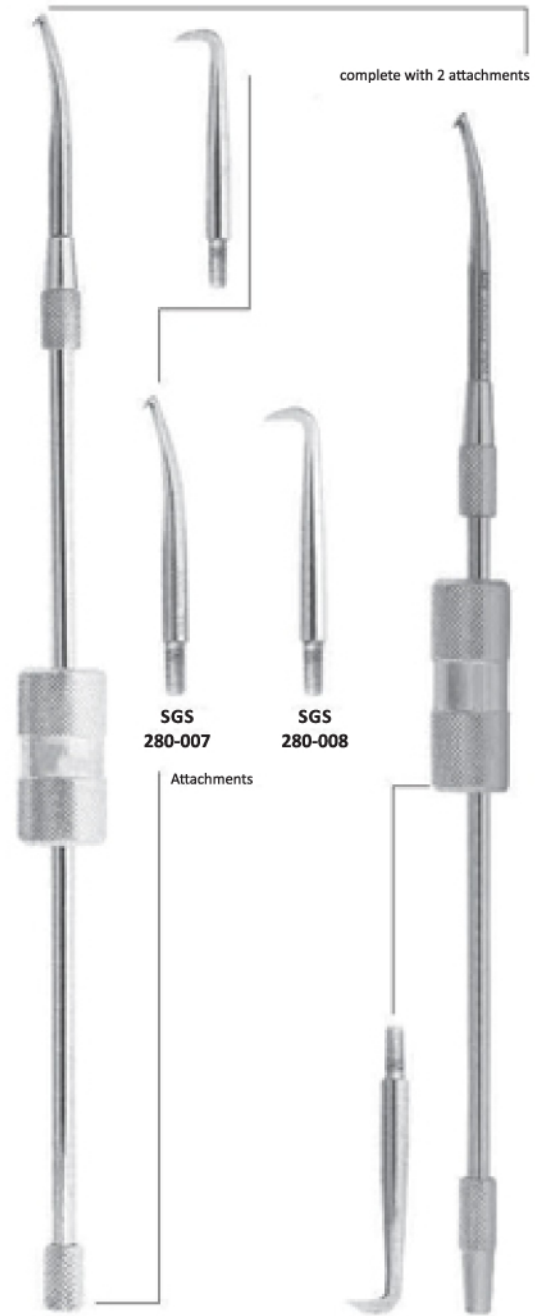

SGS 280-006

SGS 280-009



**280** Dental Crown Removers, Scissors, Forceps, Amalgum Guns & Carriers



**Universal "HM"**  
12 cm, 4 3/4"



**SGS 280-010**



**SGS 280-011**



**SGS 280-012**  
Beebee  
10,5 cm, 4 1/8"



**SGS 280-013**  
Mershon



**SGS 280-015**  
Morell



**SGS 280-016**  
Morell



**SGS 280-017**  
Morell



**SGS 280-018**  
Treymann



**SGS 280-019**  
Automatic Crown remover  
with 2 points



**SGS 280-020**



**SGS 280-021**

# **Amalgum Guns & Carriers**





**290**

## Amalgum Guns & Carriers



**SGS 290-001**  
Medium-Large  
20 cm

**SGS 290-002**  
Medium-Jumbo  
20 cm

**SGS 290-003**  
Large-Jumbo  
20 cm

**SGS 290-004**  
Jumbo-Jumbo  
20 cm

**SGS 290-005**  
Medium  
15.5 cm

**SGS 290-006**  
Large  
15.5 cm

**SGS 290-007**  
Jumbo  
15.5 cm



**Ø2 mm**

**Ø2 mm**  
**SGS 290-008**  
Straight  
15 cm

**Ø2 mm**  
**SGS 290-009**  
15 cm

**SGS 290-010**  
15 cm



**SGS 290-011**  
Alamgum Well  
Non skid base  
Ø3.5 mm

# **Ring Removing Pliers**



**300**

**Copper Ring Removing Pliers, Paper Articulator Forceps**



**SGS 300-001**  
Bohm  
11,5 cm



**SGS 300-002**  
Bohm  
14,5 cm



**SGS 300-003**  
Furrer  
16 cm



**SGS 300-004**  
Furrer  
16 cm

copper ring removing pliers



**SGS 300-005**  
Miller  
15 cm



**SGS 300-006**  
Miller  
15 cm



**SGS 300-007**  
Kelly  
14 cm



**SGS 300-008**  
Halstead, Mosquito  
12 cm



**SGS 300-009**  
Micro, Mosquito  
10 cm

**Rongeurs**



## 310

## Rongeurs



**SGS 310-001**  
Friedmann  
14 cm, 5½"

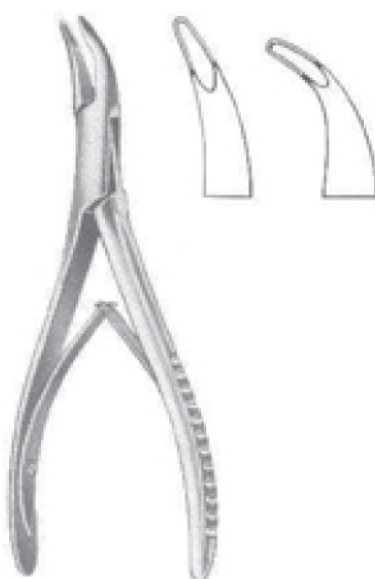

**SGS 310-002**  
14 cm, 5½"

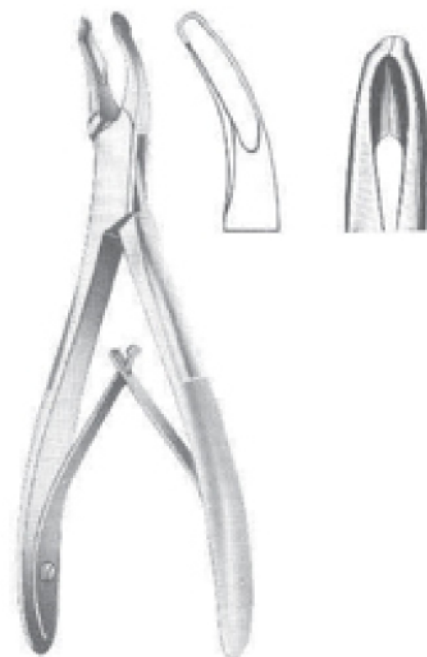

**SGS 310-003**  
Mead  
14 cm, 5½"



**SGS 310-004**  
Mead  
14 cm, 5½"



**SGS 310-005**  
Mead  
17 cm, 6¾"

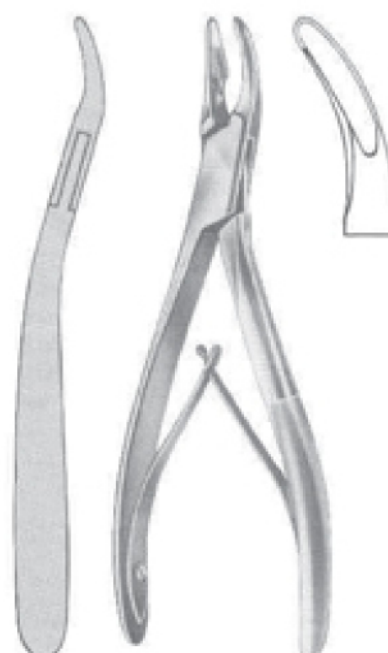

**SGS 310-006**  
Schell  
17 cm, 6¾"



## 310

## Bone Rongeurs



**SGS 310-007**  
Luer  
15 cm



**SGS 310-008**  
Friedmann  
14 cm



**SGS 310-009**  
Mini Friedmann  
12 cm



**SGS 310-009**  
Goldman-Fax  
10 cm



**SGS 310-010**  
Blumenthal  
15 cm



**SGS 310-011**  
Blumenthal 45  
14,5 cm



**SGS 310-012**  
Blumenthal 90  
14 cm



**SGS 310-013**  
Bohler  
15 cm



**SGS 310-014**  
Kerrison  
15 cm



## 310

## Rongeurs



**SGS 310-015**  
Blumenthal  
16 cm, 6 1/4"



**SGS 310-016**  
Blumenthal  
16 cm, 6 1/4"



**SGS 310-017**  
Blumenthal  
16 cm, 6 1/4"



**SGS 310-018**  
Kleinert-Kurtz  
14 cm, 5 1/2"



**SGS 310-019**  
Ruskin-Mini  
15 cm



**SGS 310-020**  
Beyer  
18 cm, 7 1/8"



**SGS 310-021**  
Zaufal-Jansen  
18 cm, 7 1/8"



## 310

## Rongeurs



**SGS 310-022**  
Niro  
No. 5 S, 14 cm, 5½"



**SGS 310-023**  
Cleveland  
No. 5 S, 17 cm, 6¾"



**SGS 310-024**  
No. 18 S, 15 cm, 6"



**SGS 310-025**  
Cleveland  
16 cm, 6¼"



**SGS 310-026**  
Gardner  
16 cm, 6¼"



**SGS 310-027**  
Liston-Mini  
15 cm, 6"



# **Bone Elevators, Files & Chisels**



## 320 Bone Elevators

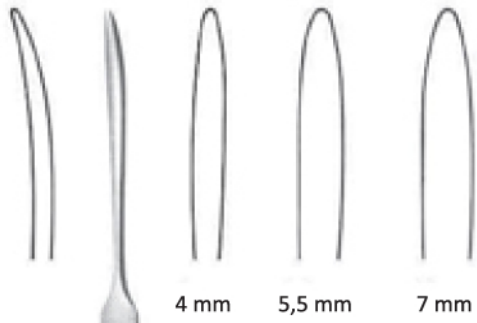

4 mm      5,5 mm      7 mm

**Blunt**

**SGS 320-001**  
Williger  
16 cm, 6 1/4"

5 mm

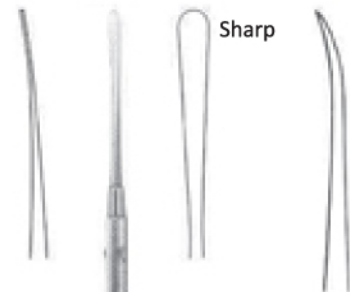

Sharp

Sharp

Sharp

Sharp

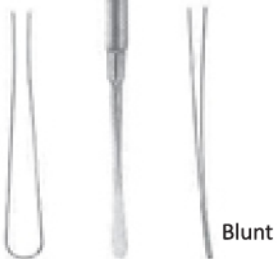

Blunt



Blunt

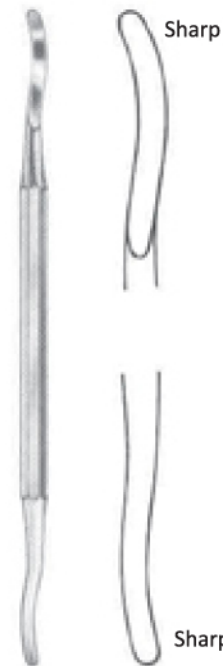

Sharp



Blunt

**SGS 320-003**  
Freer  
19 cm, 7 1/2"

**SGS 320-004**  
Bennet  
17 cm, 6 3/4"

**SGS 320-005**  
Seldin  
19 cm, 7 1/2"

**SGS 320-006**  
Seldin  
19 cm, 7 3/4"



## 320

### Bone Files and Chisels



**Buckley**  
15 cm, 6"



**SGS 320-007**  
No.1  
3 cm



**SGS 320-008**  
No.2  
4 cm



**SGS 320-009**  
No.3  
5 cm



**SGS 320-010**  
No.4  
4 cm



**SGS 320-011**  
No.5  
4 cm



**SGS 320-012**  
**Killian**  
16 cm, 6 1/4" 5 mm



**SGS 320-013**  
**Killian-Claus**  
16 cm, 6 1/4" 5 mm



**Obwegeser**



**SGS 320-014**  
2,5 mm



**SGS 320-015**  
4 mm



**SGS 320-016**  
**Miller**  
No.10C



**SGS 320-017**  
**Miller**  
No.11C

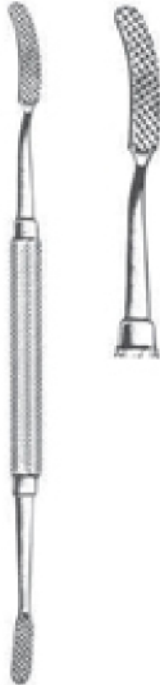

**SGS 320-018**  
**Miller**  
No.12C



**SGS 320-019**  
**Miller**  
No.13C

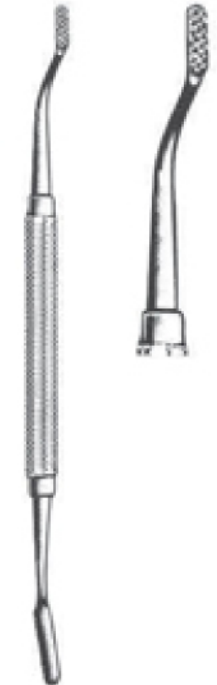

# **Orthodontic Pliers**



**330**

**Pliers for Orthodontic**



**SGS 330-001**  
**Adams**  
 Adams pliers for bending  
 wires up to 0,7 mm (.28")

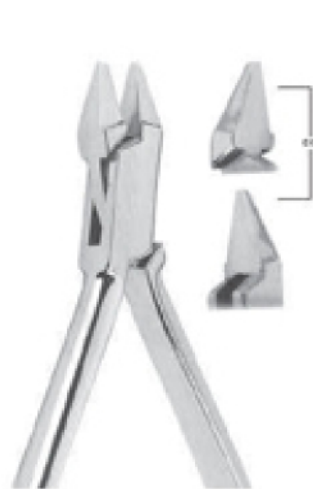

**SGS 330-002**  
**Adams**  
 Adams pliers for bending  
 wires up to 0,7 mm (.28")



**SGS 330-003**  
**Adams**  
 Tweed loop forming pliers.  
 for forming loop in wires up  
 to 0,56 mm (.22")



**SGS 330-004**  
**Adams**  
 Aderer three jaws bending  
 pliers. for wires up to 0,7 mm (.28")



**SGS 330-005**  
**Adams**  
 Aderer three jaws bending  
 pliers. for wires up to 0,7 mm (.28")



**SGS 330-006**  
Micro-miniature light wire cutter. it cuts soft ligature wires. for use in case of limited access. Caution: maximum cutting capacity: soft ligature wire up to 0,30mm (.012")



**SGS 330-007**  
Wire cutter, for ligature wires and pins. it is strong enough to bend archwire ends after distal cutting. maximum cutting capacity up to 0,56 x 0,7mm (.022 x .028")



**SGS 330-008**  
Wire cutter, for ligature wires and pins. it is strong enough to bend archwire ends after distal cutting. maximum cutting capacity up to 0,9mm (.036")



**SGS 330-009**  
Wire cutter, for ligature wires and pins. it is strong enough to bend archwire ends after distal cutting. maximum cutting capacity up to 1,5mm (.044")



**330**

## Pliers for Orthodontic



**SGS 330-010**  
Flat nose pliers with smooth beaks for bending wires up to 0,7mm (.028")



**SGS 330-011**  
bending wires up to 0,7mm (.028")



**SGS 330-012**  
bending wires up to 0,7mm (.028")



**SGS 330-013**  
bending wires up to 0,7mm (.028")



**330**

**Pliers for Orthodontic**



**SGS 330-014**  
**Nance**

Nance loop closing pliers. for bending of stop loops and special for Adam's clasps. wires up to 0,7mm (.028")



**SGS 330-015**  
**Nance**

Universal pliers for bending wires up to 0,9mm (.035") or cutting up to 0,7mm (.028")

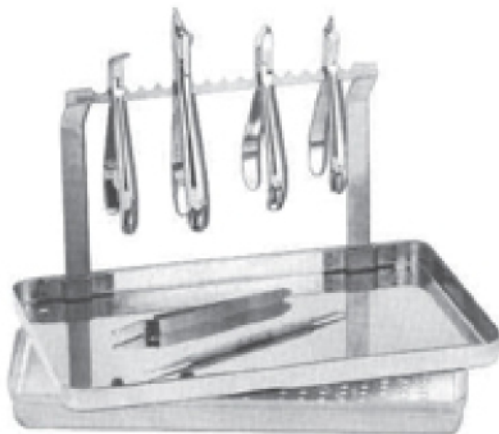

**SGS 330-016**  
Stainless steel pliers tray  
standard dimensions



**SGS 330-017**  
**Universal**

Universal pin roughening, cutting and bending pliers. for wires up to 0,9mm (.035") will cut wires up to 0,7mm (.028")





**SGS 330-018**  
**Reynolds**  
 Reynolds contouring pliers.



**SGS 330-019**  
**Reynolds**  
 Lingual arch pliers used to form double and triple back bends in 0,7mm (.028") or 0,9mm (.035") wire for insertion in lingual sheaths



**SGS 330-020**  
**Weingart**  
 Weingart pliers with serrated points



**SGS 330-021**  
**De La Rosa**  
 De La Rosa arch forming pliers. designed to form and contour arch wires on round or rectangular wire. the beaks has grooves of 0,4mm (.016") 0,46mm (.018") and 0,56mm (.022")



**SGS 330-022**  
**De La Rosa**  
 Arch forming pliers with a non grooved contouring surface the forming of precise arches.



**SGS 330-023  
Waldsachs**

Waldsachs universal pliers for bending wires up to 1,0mm (0.39") cutting up to 0,7mm (.028")



**SGS 330-024**

Round and concave pliers for loop forming and bending of thin round and square wires up to 0,5mm (0.20")



**Loop former Pliers**



**SGS 330-025  
Tweed**

Tweed loop forming pliers. for round or rectangular wires up to 0,56 x 0,7mm (.022" x .028"). replaceable cylindrical beak with three.

**Sizes:** 1,15mm (.045"), 1,50mm (.059"), 1,90mm (.075"). concave beak with slightly parallel serration, to keep the wire in proper position.



**SGS 330-026  
Tweed**

Tweed loop forming pliers. for making perfect omega loops with round or rectangular wires up to 0,56 x 0,7mm (.022" x .028").



**SGS 330-027  
Tweed**

Single diameter loop forming pliers. wire up to 0,56 x 0,7mm (.022" x .028"). replacement concave beak has only diameter section of 1,50mm (.059")





**Distal end cutters**



**SGS 330-028**

Distal end cutter-safety hold-a precision cutter designed for distal arch cutting in the patient's mouth. it cuts the hard wires end holds the loose distal end preventing any damaging of oral tissue. maximum cutting capacity rectangular wires up to 0,56 x 0,7mm (.022" x .020")



**SGS 330-029**

Micro-dital end cutter-safety hold.



**SGS 330-031**

Direct bondattachment remover (angled). For removing all bonded attachments. may be used misel-distal-horizontal or incisal-gingival (vertical) in anterior areas. angled perfectly for easy access to difficult pesterer areas.





**SGS 330-032**  
Wire bending pliers for wires up to 0,9mm (.036")



**SGS 330-033**  
Bird beak angle pliers for bending round, square or rectangular wire up to 0,7mm (.028").



**SGS 330-034**  
Double rounded jaw wire bending pliers. for wires up to 0,7mm (.028").



**SGS 330-035**  
Bird beak pliers for bending round, rectangular or square wire up to 0,7mm (.028") with cutter.



**SGS 330-036**  
Double rounded jaws wire bending pliers. for wires up to 0,7mm (.028").

**Bird Beak Pliers**



## 330 Pliers for Orthodontic



**SGS 330-037**  
USA Model  
125 mm



**SGS 330-038**  
Aldron  
125 mm



**SGS 330-039**  
How  
140 mm



**SGS 330-040**  
How  
145 mm



**SGS 330-041**  
Adams  
125 mm



**SGS 330-042**  
Angle  
125 mm



**SGS 330-043**  
Young  
130 mm



**SGS 330-044**  
Nance  
133 mm



**SGS 330-045**  
Weingart  
140 mm



**SGS 330-041**  
Johnson  
130 mm



**SGS 330-042**  
MC Kellops  
155 mm



**SGS 330-043**  
Universal  
150 mm



**SGS 330-044**  
Waldsachs  
155 mm



**SGS 330-045**  
Aderer  
125 mm



**SGS 330-046**  
Nance  
130 mm





## 330

### Pliers for Orthodontic and Prosthetics



**SGS 330-047**  
Langenbeck  
140 mm



**SGS 330-048**  
Langenbeck  
130 mm



**SGS 330-049**  
Langenbeck  
130 mm



**SGS 330-050**  
Peeso  
125 mm



**SGS 330-051**  
Goslee  
125 mm



**SGS 330-052**  
Fischer  
140 mm



**SGS 330-053**  
Andresen  
130 mm



**SGS 330-054**  
Schwarz  
130 mm



**SGS 330-055**  
MSY  
130 mm



**SGS 330-056**  
Langenbeck  
125 mm



**SGS 330-057**



**SGS 330-058**



**SGS 330-059**



**SGS 330-060**



**SGS 330-061**



**SGS 330-062**



**SGS 330-063**



## 330 Pliers for Orthodontic and Prosthetics



SGS 330-064



SGS 330-065



SGS 330-066

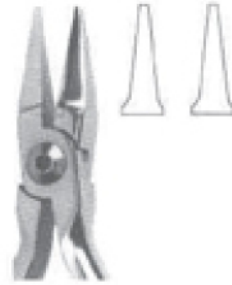

SGS 330-067



SGS 330-068



SGS 330-069



SGS 330-070



SGS 330-071



SGS 330-072



SGS 330-073



SGS 330-074



SGS 330-075



SGS 330-076



SGS 330-077



SGS 330-078



SGS 330-079



SGS 330-080



SGS 330-081

# **Impression Trays**





## 340 Stainless Steel Impression Trays

All Impression Trays Upper & Lower type are available in S,M,L and XL Sizes



**SGS 340-001**  
"HYDRO-LOCK"  
Stainless steel  
water-cooled impression  
trays with retention rim.



**SGS 340-002**  
"HYDRO-LOCK"  
Stainless steel  
water-cooled impression  
trays with retention rim.



**SGS 340-003**  
"NEW SUPER"  
Stainless steel impression  
trays with retention rim.



**SGS 340-004**  
"NEW SUPER"  
Stainless steel impression  
trays with retention rim.



**SGS 340-005**  
"ANATOMIC"  
solid regular Stainless steel  
impression trays without retention rim.



**SGS 340-006**  
"ANATOMIC"  
solid regular Stainless steel  
impression trays without retention rim.



**SGS 340-007**  
Perforated-total denture  
stainless steel impression  
trays with rim.



**SGS 340-008**  
Perforated-total denture  
stainless steel impression  
trays with rim.



## 340

### Stainless Steel Impression Trays

All Impression Trays Upper & Lower type are available in S,M,L and XL Sizes



**SGS 340-009**  
"PERMA LOCK" solid regular stainless steel impression trays with rim.



**SGS 340-010**  
"PERMA LOCK" solid regular stainless steel impression trays with rim.



**SGS 340-011**



**SGS 340-012**



**SGS 340-013**



**SGS 340-014**



**SGS 340-015**



**SGS 340-016**



**SGS 340-017**  
Set of Six

#### Packaging



**SGS 340-018**  
Set of Eight



**SGS 340-019**  
Solid stainless steel anterior depressed impression tray with retention rim



**SGS 340-020**

**SGS 340-021**

**SGS 340-022**



**SGS 340-023**



**SGS 340-024**



**SGS 340-025**



**SGS 340-026**  
Solid stainless steel anterior depressed impression tray with retention rim



## 340 Stainless Steel Impression Trays

All Impression Trays Upper & Lower type are available in S,M,L and XL Sizes



**SGS 340-027**  
Fig 0 per bambini - for children



**SGS 340-028**  
for narrow toothed upper jaws



**SGS 340-029**  
Fig 0 per bambini - for children



**SGS 340-030**  
For partially toothed upper jaws



**SGS 340-031**  
For partially toothed lower jaws



**SGS 340-032**  
For edentulous upper jaws



**SGS 340-033**  
For edentulous lower jaws



## 340 Stainless Steel Impression Trays

All Impression Trays Upper & Lower type are available in S,M,L and XL Sizes



**SGS 340-034**  
Solid total denture stainless steel impression tray with rim.



**SGS 340-035**  
Solid total denture stainless steel impression tray with rim.



**SGS 340-036**  
"PERMA-LOCK" perforated regular stainless steel impression tray with rim.



**SGS 340-037**  
"PERMA-LOCK" perforated regular stainless steel impression tray with rim.



**SGS 340-038**  
perforated stainless steel anterior depressed impression tray with rim.

**SGS 340-043**   **SGS 340-044**   **SGS 340-045**



**SGS 340-040**   **SGS 340-041**   **SGS 340-042**



**SGS 340-046**  
perforated stainless steel anterior depressed impression tray with rim.



**SGS 340-047**  
perforated stainless steel without retention rim impression tray for complete denture



**SGS 340-048**  
perforated stainless steel without retention rim impression tray for complete denture

# **Articulators**



**350**

## Articulators

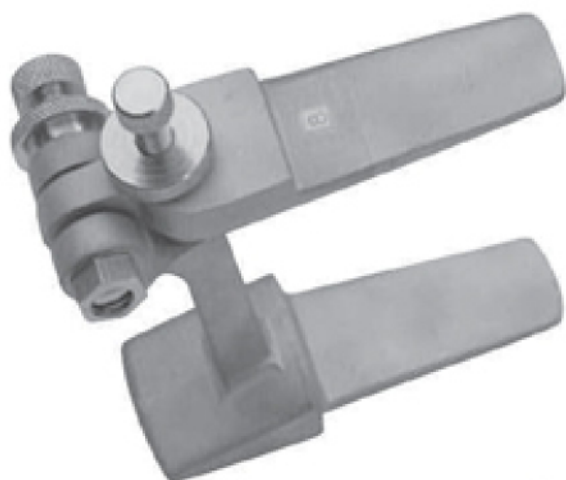

SGS 350-001



SGS 350-002



SGS 350-003



SGS 350-004

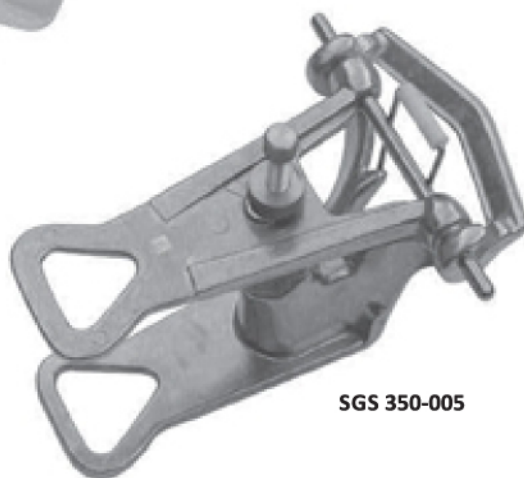

SGS 350-005



SGS 350-006



**350**

## Articulators

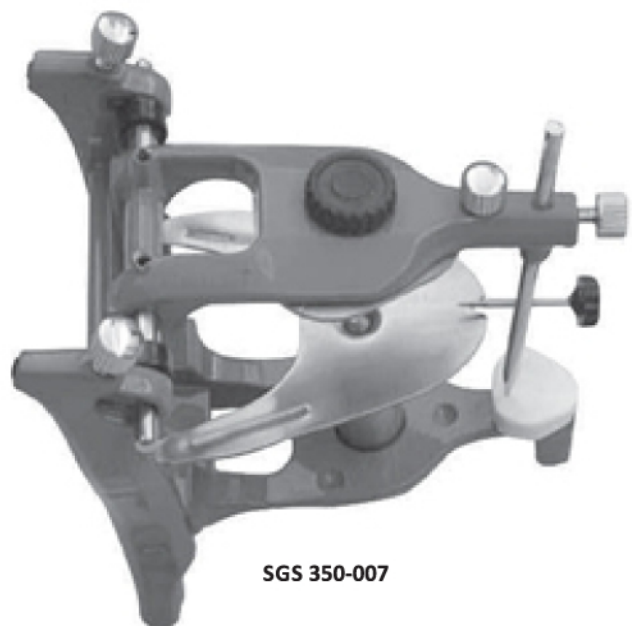

SGS 350-007



SGS 350-008



SGS 350-009

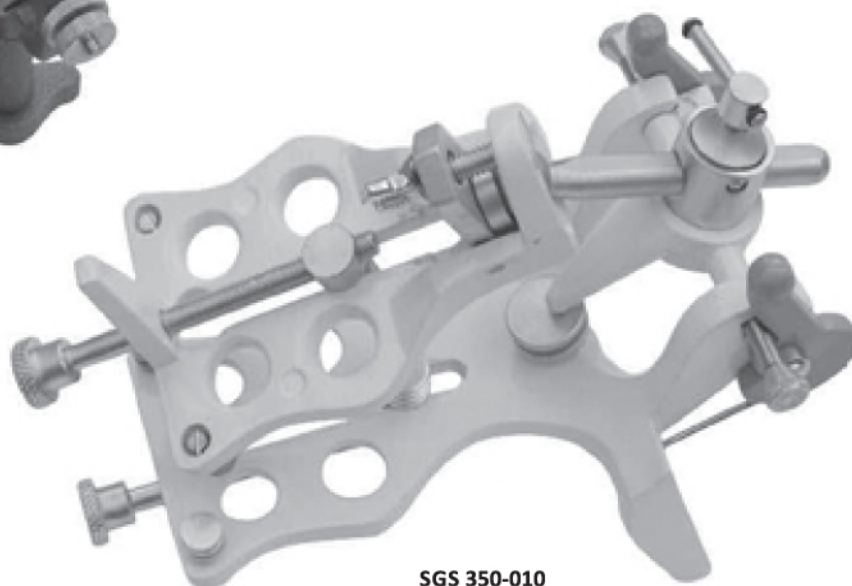

SGS 350-010

**Hollowares**





**350** Dental and surgical Hollowares



**SGS 350-011**  
ENDODONTIC BOX

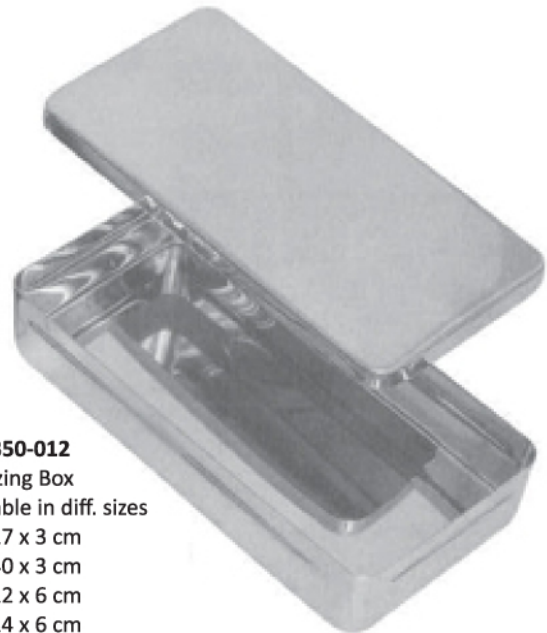

**SGS 350-012**  
Sterilizing Box  
Available in diff. sizes  
17 x 17 x 3 cm  
20 x 40 x 3 cm  
25 x 12 x 6 cm  
30 x 14 x 6 cm



**SGS 350-013**  
ENDO TRAY BOX



**SGS 350-014**  
Cotton Dispenser



**SGS 350-015**  
Alcohol Lamp



**SGS 350-016**



**SGS 350-017**



**SGS 350-018**



**350** Dental and surgical Hollowares

**Sterilizing Boxes**



**SGS 350-019**



**SGS 350-020**



**SGS 350-021**

**Sterilizing Boxes**



**SGS 350-022**



**SGS 350-023**



**SGS 350-024**



**SGS 350-025**



**SGS 350-026**



**SGS 350-027**

**FORCEP AND THERMOMETER JARS**



**SGS 350-028**  
IRRIGATOR (Douch Can)



**SGS 350-029**  
Measuring Jug



**SGS 350-030**  
Kidney Tray



## 350 Dental and surgical Hollowares



**SGS 350-031**  
Forcep Jar



**SGS 350-032**  
Gallipot with and without lid



**SGS 350-033**  
Spitten Mug



**SGS 350-034**  
Spirit Lamp



**SGS 350-035**  
Perforated Tray



**SGS 350-036**  
Perforated Base



**SGS 350-037**  
Solid Tray



**SGS 350-038**  
Instruments Tray



**SGS 350-039**  
Instruments Tray



**SGS 350-040**  
Instruments Tray  
(Perforated)



**SGS 350-041**  
Instruments Tray Shallow  
(Mayo)



**SGS 350-042**  
Scalers Trays



**SGS 350-043**  
Cathetar Tray

# **Nepkin Holders & Finger Protectors**



**360** **Nepkin Holder and Finger Protectors**



**SGS 360-001**  
Napkin Holder Metal Chain



**SGS 360-002**  
Langenbeck  
Finger Protectors

# Retractors



**370**

## Retractors

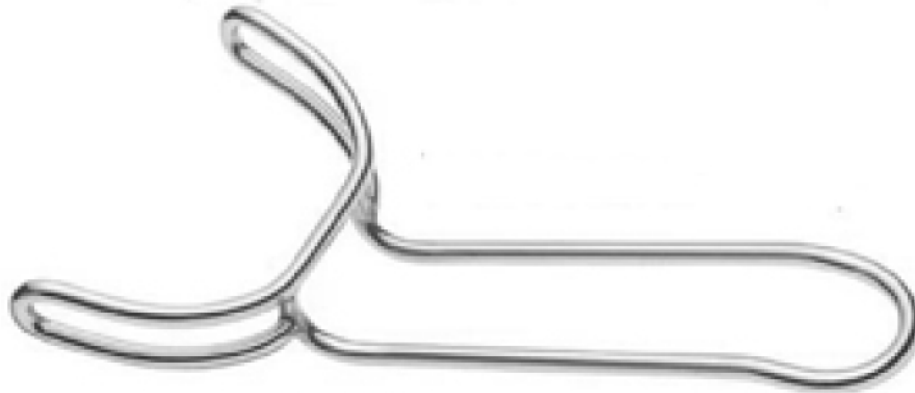

**SGS 370-001**  
Implant Retractor

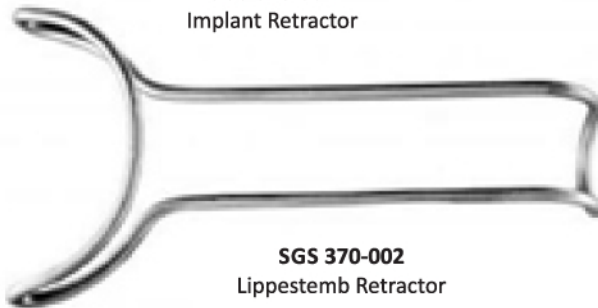

**SGS 370-002**  
Lippestemb Retractor



**SGS 370-003**  
Smal, Medium, Large  
Mouth Gags Oringer



**SGS 370-004**  
Universal Retractor



## 370

## Retractors



**SGS 370-001  
STEMBERG**  
Sizes: 12 cm, 14 cm, 16 cm



**SGS 370-002  
STEMBERG**  
Sizes: 12 cm, 14 cm, 16 cm



**SGS 370-003  
STEMBERG**  
Sizes: 12 cm, 14 cm, 16 cm



**SGS 370-004  
COLIMBIA RETRACTORS**





**DELIVERING PRODUCTS TO THE HEALING HANDS**

Tax ID: 0105561085653



info@surgyx.com | www.surgyx.com  
SurGyx Surgical Company Limited  
233/90 Sanpawut Town Sanpawut Road,  
Bangna Bangkok, Thailand 10260