

New Edition



SurGyx

Delivering Products to the Healing Hands

OPHTHALMIC INSTRUMENTS



Barraquer Wire Speculums
SP10-1001
 standard wire, 10mm blades



Barraquer Wire Speculums
SP10-1002
 heavy wire, 15mm blades



Barraquer Wire Speculums
SP10-1003
 standard wire, 15mm blades



Barraquer Wire Speculums
 Wire Speculum
SP10-1004
 15mm blades



Barraquer Wire Speculums
 Wire Speculum
SP10-1005
 9mm blades (infant)



Barraquer Wire Speculums
 Wire Speculum
SP10-1006
 14mm blades



Temporal Approach
 Wire Speculum
 with spring on nasal side
SP10-1007
 15mm closed blades



Temporal Approach
 Wire Speculum
 with spring on nasal side
SP10-1008
 15mm open blades



Barraquer Solid Blade
 Wire Speculum
SP10-1009
 Barraquer, 10mm blades



Barraquer Solid Blade
 Wire Speculum
SP10-1010
 Barraquer, 15mm blades



Barraquer Solid Blade
 Wire Speculum
SP10-1011
 Feaster, 20mm blades



Kratz - Barraquer
Wire Speculum
15mm blades
one solid and one open wire
SP-10-1012
for right eye



Kratz - Barraquer
Wire Speculum
15mm blades
one solid and one open wire
SP-10-1013
left eye

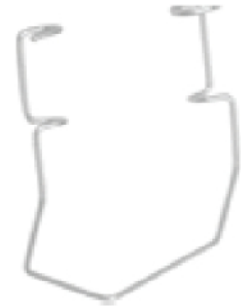

Kratz - Barraquer
Wire Speculum with open blades
SP-10-1014
heavy wire, 15mm blades



Kratz - Barraquer
Wire Speculum with open blades
SP-10-1015
standard wire, 15mm blades



Kratz - Barraquer
Wire Speculum with open blades
SP-10-1016
standard wire, 13mm blades



Barraquer Wire Speculums
Wire Speculum with wings
For retracting the lids
up and away from the globe
to eliminate external pressure
SP-10-1017
15mm blades



Nevyas Speculum
Wire Speculum Designed to retain
surgical drape under the eye lids while
allowing unobstructed access to the
cataract incision with phaco or I/A tip.
SP-10-1018
16mm blades



McIntyre
Wire Speculum gently curved springs
V-shaped blades are designed to
retain surgical drape under the eye lids
SP-10-1019
closed wire, 13mm blades



McIntyre
Wire Speculum gently curved springs
V-shaped blades are designed to
retain surgical drape under the eye lids
SP-10-1020
openwire, 13mm blades



Sauer
 Lid Speculum
SP-10-1021
 for infants, 11mm blades



Sauer
 Lid Speculum
SP-10-1022
 for premature infants, 2mm blades



Frankel
 Infant Lid Speculum adjustable
 For precise control of
 infant eyelid retraction.
SP-10-1023
 10mm blades



Alphonso
 Infant Lid Speculum finger grips and
 interlacing blades to facilitate insertion
 one blade 5mm, one blade 7mm
SP-10-1024



Alphonso
 Infant Lid Speculum finger grips and
 interlacing blades to facilitate insertion
 one blade 5mm, one blade 7mm
SP-10-1025
 4mm blades



Cook Eye Speculum
 Eye Speculum with locking screw
SP-10-1026
 8mm blades



Cook Eye Speculum
 Eye Speculum with locking screw
SP-10-1027
 11mm blades



Cook Eye Speculum
 Eye Speculum with locking screw
SP-10-1028
 15mm blades



Murdoch
 Eye Speculum with locking screw
SP-10-1029 12mm blades
SP-10-1030 15mm blades



Mellinger
 Eye Speculum self retaining
 For unobstructed access to the
 cataract incision with phacoorl/Atip.
SP-10-1031
 15mm blades



Williams
 Eye Speculum with locking screw
SP-10-1032 11mm blades
SP-10-1033 15mm blades



Knapp
 Eye Speculum
SP-10-1034
 13mm blades



Lancaster Speculum
 Eye Speculum
 adjustable mechanism
 with locking nut
SP-10-1035
 16mm blades



Lester-Burch Speculum
 Eye Speculum with flanges on
 blades for retaining eye lashes
 adjustable mechanism
 with locking screw
SR-10-1036
 11mm blades



Lieberman Speculum
 adjustable mechanism

- SP-10-1037** Lieberman, K-wire, 10mm blades, standard
- SP-10-1038** Lieberman, K-wire, 15mm blades, standard
- SP-10-1039** Lieberman, V-shaped, 15mm blades
- SP-10-1040** Tanna-Lieberman, 15mm blades
- SP-10-1041** Thorlakson, rounded, 11mm blades
- SP-10-1042** Lieberman, triplepost, 13mm blades

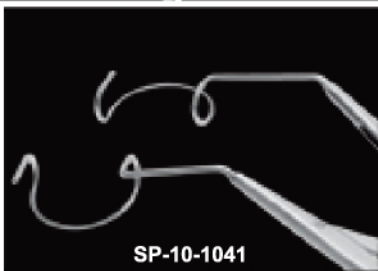
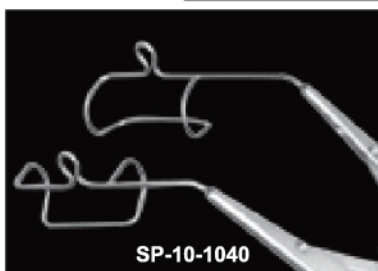
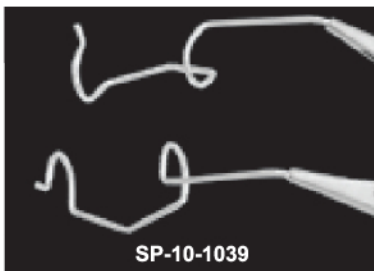
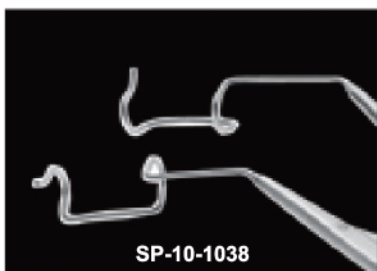



Lieberman Speculum
adjustable mechanism
SP-10-1043
Lieberman, K-wire, 15mm blades,
standard Titanium



Lieberman Speculum
Eye Speculum adjustable mechanism
non-reflective finish
SP-10-1044 10mm blades
SP-10-1045 15mm blades

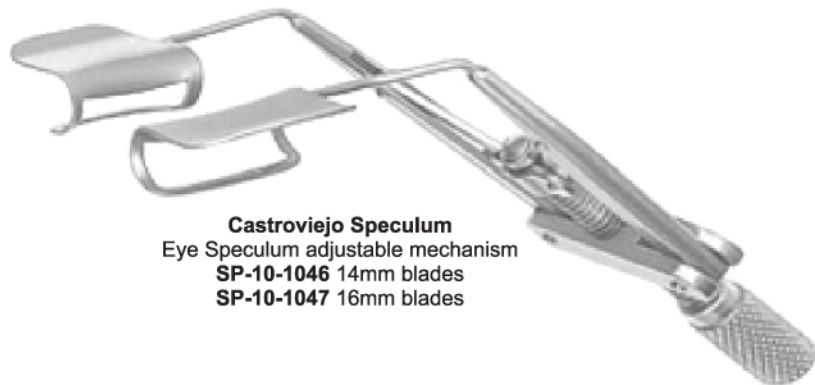

Castroviejo Speculum
Eye Speculum adjustable mechanism
SP-10-1046 14mm blades
SP-10-1047 16mm blades



Ginsberg Speculum
Eye Speculum flared upper blades
and fenestrated lowerblades
adjustable mechanism For retaining
redundant lid tissue
SP-10-1049 15mm blades

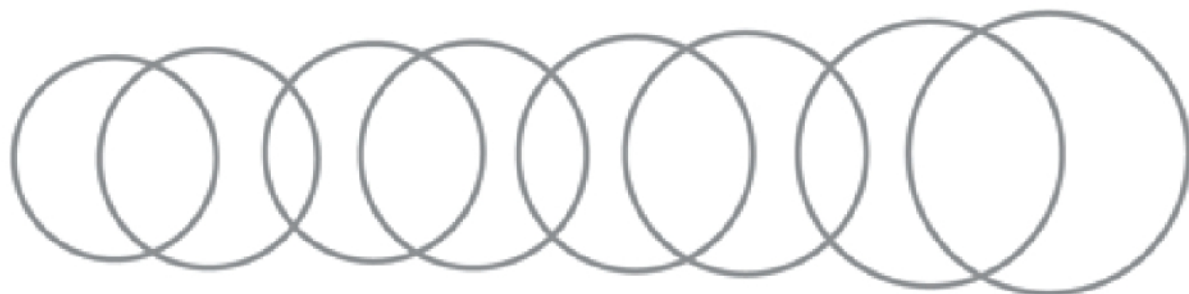

Flieringa
Scleral Fixation Ring

- SP-10-1050** Setofeight, 15mm-22mm
- SP-10-1051** 14mm diameter
- SP-10-1052** 15mm diameter
- SP-10-1053** 16mm diameter
- SP-10-1054** 17mm diameter
- SP-10-1055** 18mm diameter
- SP-10-1056** 19mm diameter
- SP-10-1057** 20mm diameter
- SP-10-1058** 21mm diameter
- SP-10-1059** 22mm diameter

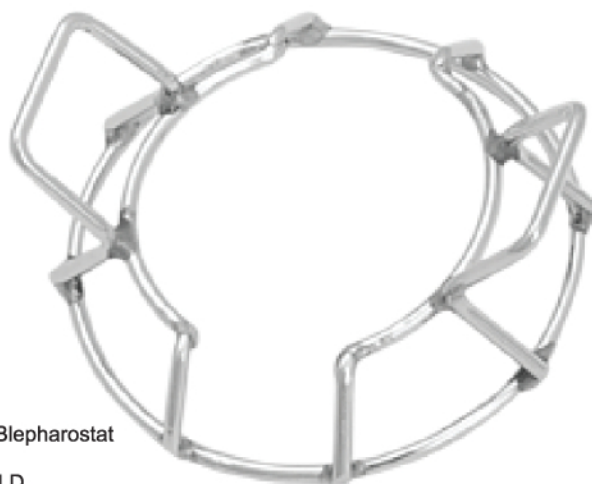

Mecneill-Goldman
Scleral Fixation Ringand Blepharostat

- SP-10-1060** small, 15mm I.D.
- SP-10-1061** medium, 16mm I.D.
- SP-10-1062** large, 17mm I.D.



WEISS
EYE SPECULUM
Fenestrated
SP-10-1063



Liebermann Tennat Speculum
EYE SPECULUM
Fenestrated, openblades
SP-10-1064



Schocket
Scleral Depressor
double-end with pocketclip
RT-10-1065



Schepens
Orbital Retractor
RT-10-1066

Desmarres
Lid Retractor
thin solid blades

- RT-10-1069 size 0, 11mm wide
- RT-10-1070 size 1, 13mm wide
- RT-10-1071 size 2, 15mm wide
- RT-10-1072 size 3, 17mm wide



Lieberman Speculum
adjustable mechanism
RT-10-1067
Lieberman, K-wire, 15mm blades,
standard Titanium

Jaeger
Lid Plate
stainless steel (small)
RT-10-1073





Jaeger
Lid Plate
stainless steel (large)
RT-10-1074



Knapp
Lacrimal Retractor
4 prongs
RT-10-1076 blunt
RT-10-1077 sharp



Helveston
Tissue Retractor thin curved blade
RT-10-1078 "Barbie" 7mm wide
RT-10-1079 "BigBarbie" 9mm wide
RT-10-1080 "GreatBigBarbie" 11mm wide,
concave blade.



Stevenson
Lacrimal Sac Retractor
solid blades with serrated edge adjustable
RT-10-1082



Wright
Fascia Needle
1mm x 6mm oval hole
140mm long
RT-10-1075

Stevenson
Lacrimal Sac Retractor
3x3 blunt prongs, adjustable
RT-10-1081



Gill
Corneal Knife
curved cutting edge
KN-20-1001



Tooke
Corneal Knife
straight blade
with curved cutting edge
KN-20-1002



Fukasaku
"Hockey" Knife
sharp 3mm front edge semi-sharp
6mm bottom edge
KN-20-1003



Foreign body spuds

- KN-20-1004** Golf Club, angled, lightly rounded tip
- KN-20-1005** Francis, angled, flag shaped tip
- KN-20-1006** Ellis, lightly curved and rounded tip

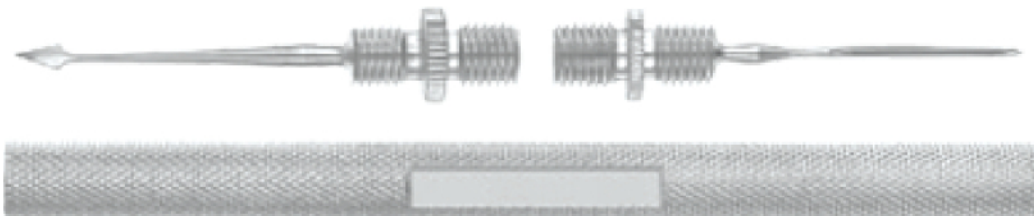

Spud & Gouge
irreversible handle
For removing foreign bodies.
KN-20-1007



Swiss Model
 Blade Breaker and Holder
 spherical tip
BB-20-1008



Castroviejo
 Blade Breaker
 and Holder
 with sliding lock
BB-20-1009



Gass
 Corneoscleral Punch
 1.5mm diameter head
 0.75mm deep bite
 rotatable tip for convenient positioning
BB-20-1010



Camellin style
 LASEK Trephine &
 Alcohol Retaining Well
BB-20-1011 48mm trephine
 and 8.5mm well

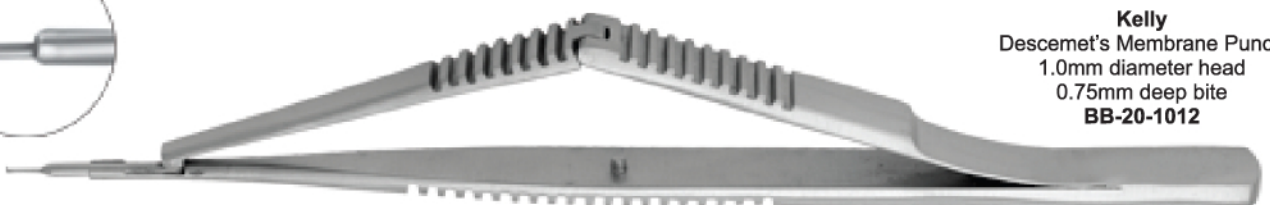
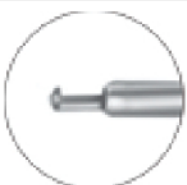

Kelly
 Descemet's Membrane Punch
 1.0mm diameter head
 0.75mm deep bite
BB-20-1012



Meyerhoefer
Chalazion Curette

- CU-30-1001**
size 0, 1.5mm dia.
- CU-30-1002**
size 1, 1.75mm dia.
- CU-30-1003**
size 3, 2.5mm dia.
- CU-30-1004**
size 4, 3.5mm dia.



Capsule
Polishing Curette
1.75mm diameter opening

- CU-30-1005** Nightingale,
semi-sharp, posteriore edge
- CU-30-1006** Shepherd,
semi-sharp, anterior and
posterior edges



Buratto
LASIK Flap Protector
blades angled 15° For retracting
and protecting superiorly
hinged corneal flaps.
CU-30-1007



Buratto
LASIK Flap Protector
For retracting and
protecting nasally hinged
corneal flaps.
CU-30-1008



Mannis-Buratto
LASIK Flap Protector
blades angled 45°
For retracting and protecting
superiorly hinged corneal flaps.
CU-30-1009



Rowen
Combination LASIK Flap
Protector and Spatula
CU-30-1010



Camellin Style
 LASEK Alcohol Well
 For retaining alcohol solution
 on the corneal epithelium.
ST-30-1011 8.5mm diameter
ST-30-1012 9.5mm diameter

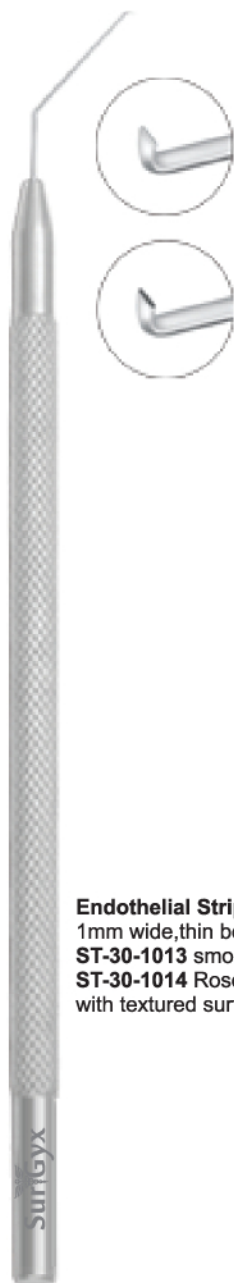

Endothelial Stripper
 1mm wide, thin beveled tip
ST-30-1013 smooth surface
ST-30-1014 Rosenwasser
 with textured surface

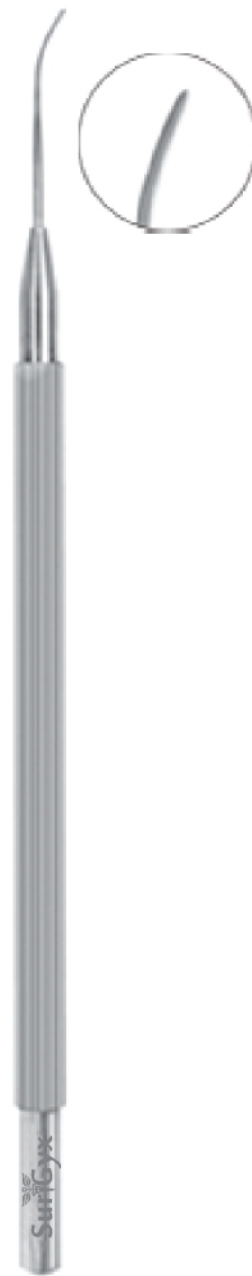

Sloane
 LASEK Flap Repositor
 gently curved spatulated tip
 with beveled smooth edges
 For repositing and smoothing
 the epithelial flap after laser ablation.
ST-30-1015



Dalk
 Corneal Dissector
ST-30-1016
 12mm long, flattened,
 vaulted spatula with
 beveled tip
ST-30-1017
 Rosenwasser DALK Trisector
 with triangular shaft and
 spatulated tip

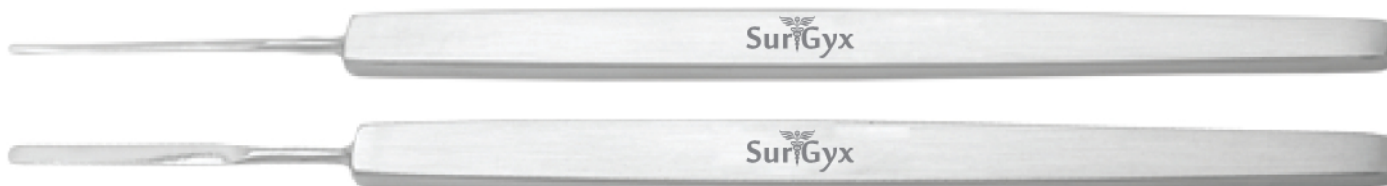

Culler
 Iris Spatula
ST-30-1018 1mm wide
ST-30-1019 2mm wide



Wheeler
Double-End Spatula
lightly curved
ST-30-1020

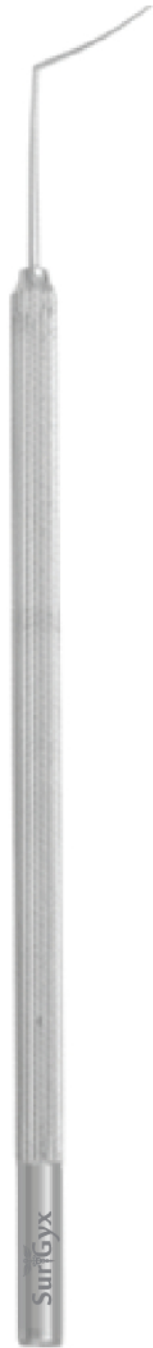

Barraquer
Iris Spatula
round, smooth
ST-30-1021 0.5mm diameter
ST-30-1022 0.25mm diameter



Gimbel
Nucleus Spatula round,
smooth angled 30° at
10mm from the tip
0.25mm diameter
ST-30-1023



Mics Phaco Pre-chopper
For bimanual nucleus pre-chopping
CH-30-1024 Alio-Rosen, with
two defined edges
CH-30-1025 Alio-Scimitar, curved
with blunt tip and sharp inferior edge



Phaco Chopper
Ball tip
0.7mm inferior wedge
CH-30-1026





Naghara
Phaco Chopper
Rounded, blunt tip
0.9mm inferior wedge
CH-30-1027



Anis
Phaco Chopper
rounded, blunt, olive-tip
offset inferior wedge
CH-30-1028 for use in right hand
CH-30-1029 for use in left hand



Chang-Seibel
Phaco Chopper
a combination chopper with the
Chang Micro Finger end and
the Seibel Vertical Safety Chopper
CH-30-1030 for use in right hand
CH-30-1031 for use in left hand



Milder
Phaco Chopper
60° offset inferior wedge
for horizontal chopping and
a beveled distal tip for
vertical chopping
CH-30-1032 for use in left hand

Milder

Phaco Chopper, double-end
60° offset inferior wedge for
horizontal chopping and a beveled
distal tip for vertical chopping.
A 12mm long spatula with a
disc-shaped tip is on the opposite end
CH-30-1033 for use in right hand
CH-30-1034 for use in left hand



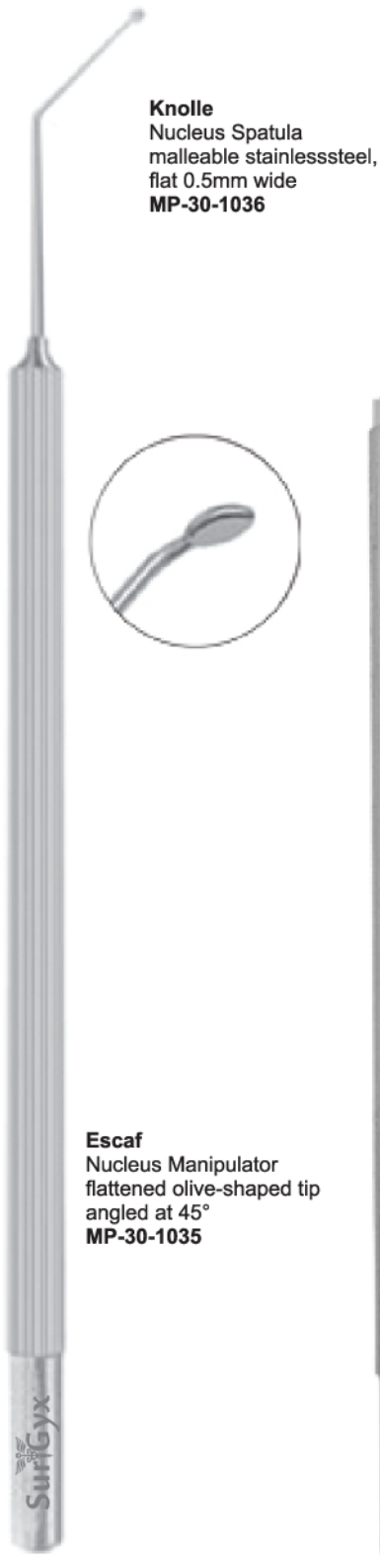

Knolle
 Nucleus Spatula
 malleable stainlesssteel,
 flat 0.5mm wide
MP-30-1036



Escaf
 Nucleus Manipulator
 flattened olive-shaped tip
 angled at 45°
MP-30-1035



Koch
 Nucleus Spatula
 gently curved duckbill
 shaped tip
MP-30-1037 smooth
MP-30-1038 with notches

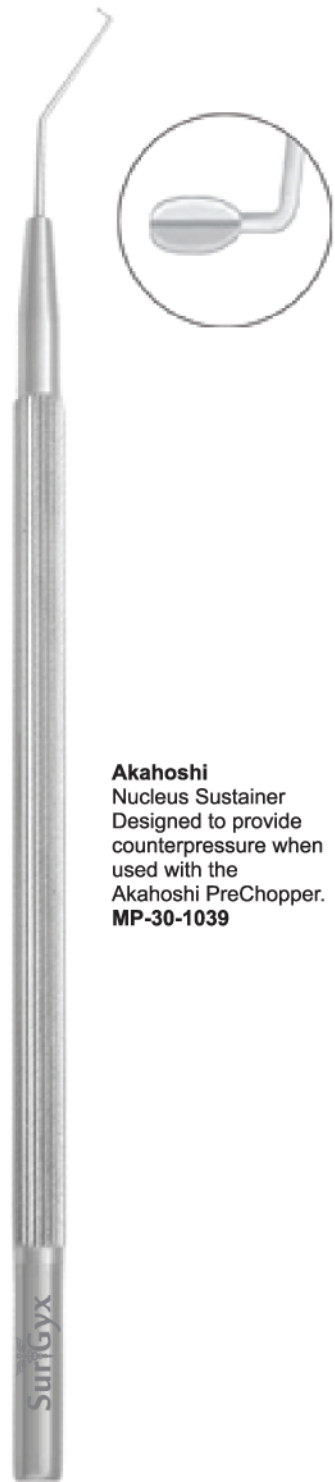

Akahoshi
 Nucleus Sustainer
 Designed to provide
 counterpressure when
 used with the
 Akahoshi PreChopper.
MP-30-1039



Escaf
 Nucleus Sustainer
 smooth ball tip
 textured inferior surface
MP-30-1040



Lieberman
MicroFinger
Nucleus Manipulator

c for use in right hand
MP-30-1041 for use in left hand



Lieberman
MicroFinger and Spatula

ST-30-1042 for use in right hand
ST-30-1043 for use in left hand



Fukasaku-Lieberman
Phaco Spatula

a combination of the
small pupil snapper hook
and the MicroFinger

ST-30-1044 for use in right hand
ST-30-1045 for use in left hand



Masket

Phaco Spatula
a combination of the Rosen
Phaco Splitter and a 12mm
long round spatula with disc
shaped tip
ST-30-1046



Chang

Phaco Chopper
a combination of a modified
MicroFinger and a 0.9mm long
"Quick Chop" tip

CH-30-1047 for use in right hand
CH-30-1048 for use in left hand





Minardi
Phaco Chopper
0.7mm long
"Quick Chop" tip
CH-30-1049

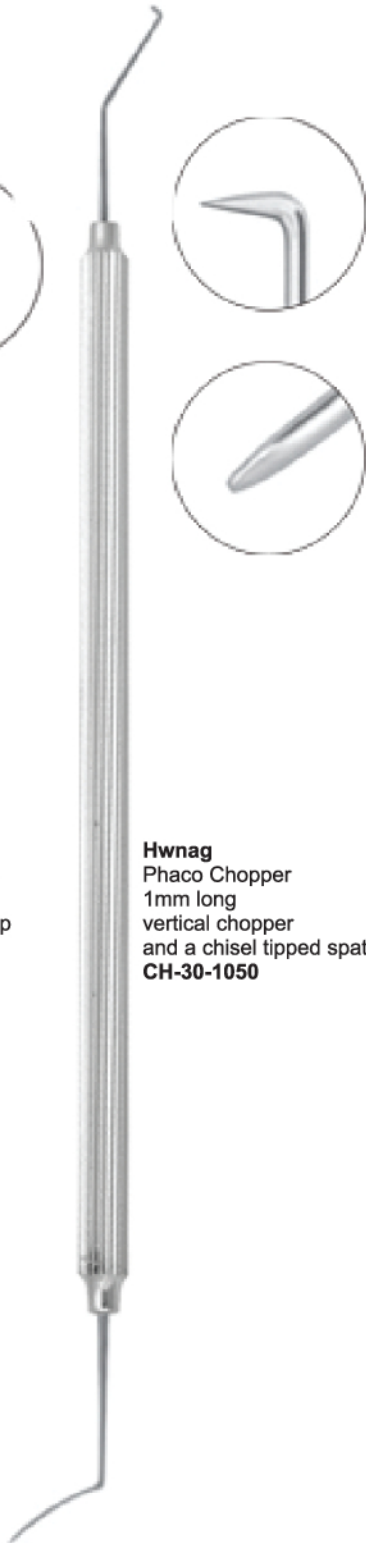

Hwnag
Phaco Chopper
1mm long
vertical chopper
and a chisel tipped spatula
CH-30-1050

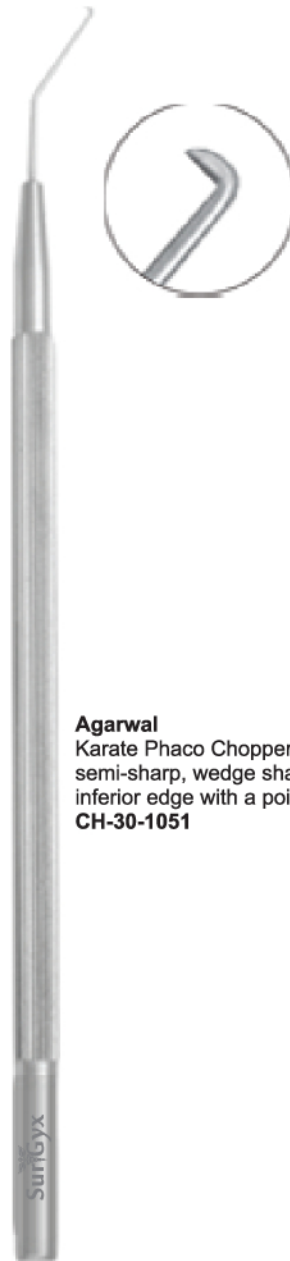

Agarwal
Karate Phaco Chopper
semi-sharp, wedge shaped
inferior edge with a pointed tip
CH-30-1051



Chang
MicroFinger Chopper
curved finger shaped tip
with defined inner edge
for horizontal chopping
CH-30-1052

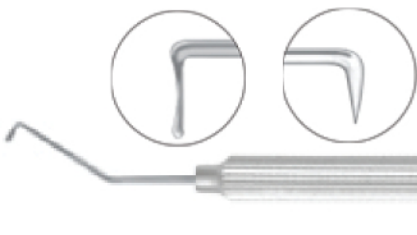

Warren
Canine Phaco Chopper
a combination of a 3.5mm long
MicroFinger and a 2mm long
pointed "Quick Chop" tip
For veterinary use only.
CH-30-1053



Brierley
 Nucleus Splitter
 with incision sealing shaft
SR-30-1054

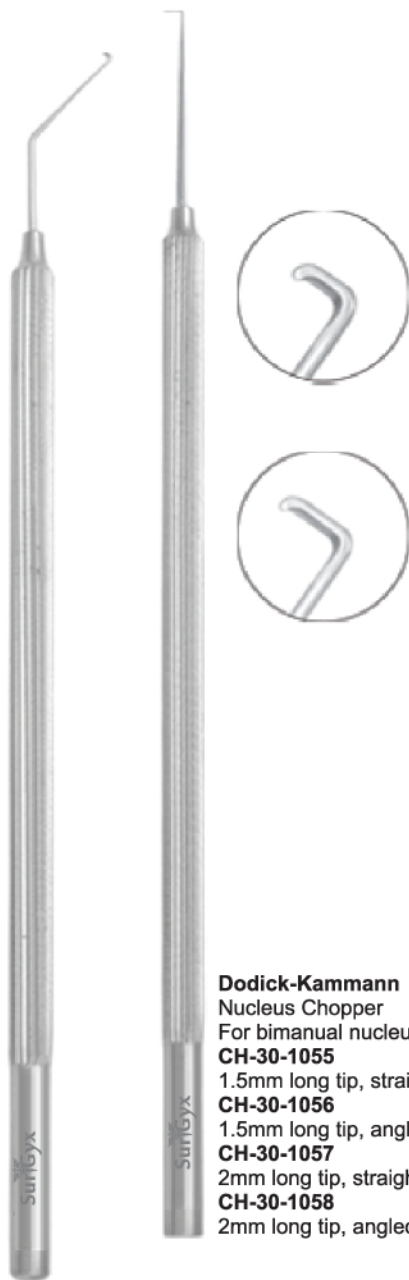

Dodick-Kammann
 Nucleus Chopper
 For bimanual nucleus division.
CH-30-1055
 1.5mm long tip, straight
CH-30-1056
 1.5mm long tip, angled
CH-30-1057
 2mm long tip, straight
CH-30-1058
 2mm long tip, angled

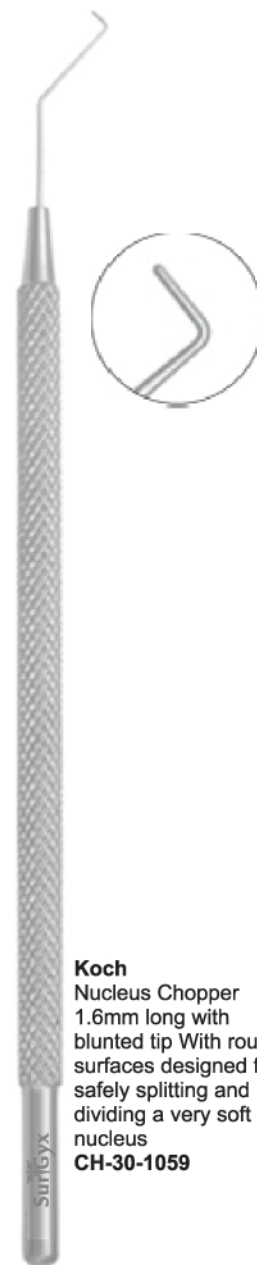

Koch
 Nucleus Chopper
 1.6mm long with
 blunted tip With rounded
 surfaces designed for
 safely splitting and
 dividing a very soft
 nucleus
CH-30-1059



Escaf
 Nucleus Divider
 1.25mm long
 wedge shaped tip
 For vertical chopping.
DV-30-1060



Neuhann
 Nucleus Divider
 strongly curved
 spatulated tip
DV-30-1061

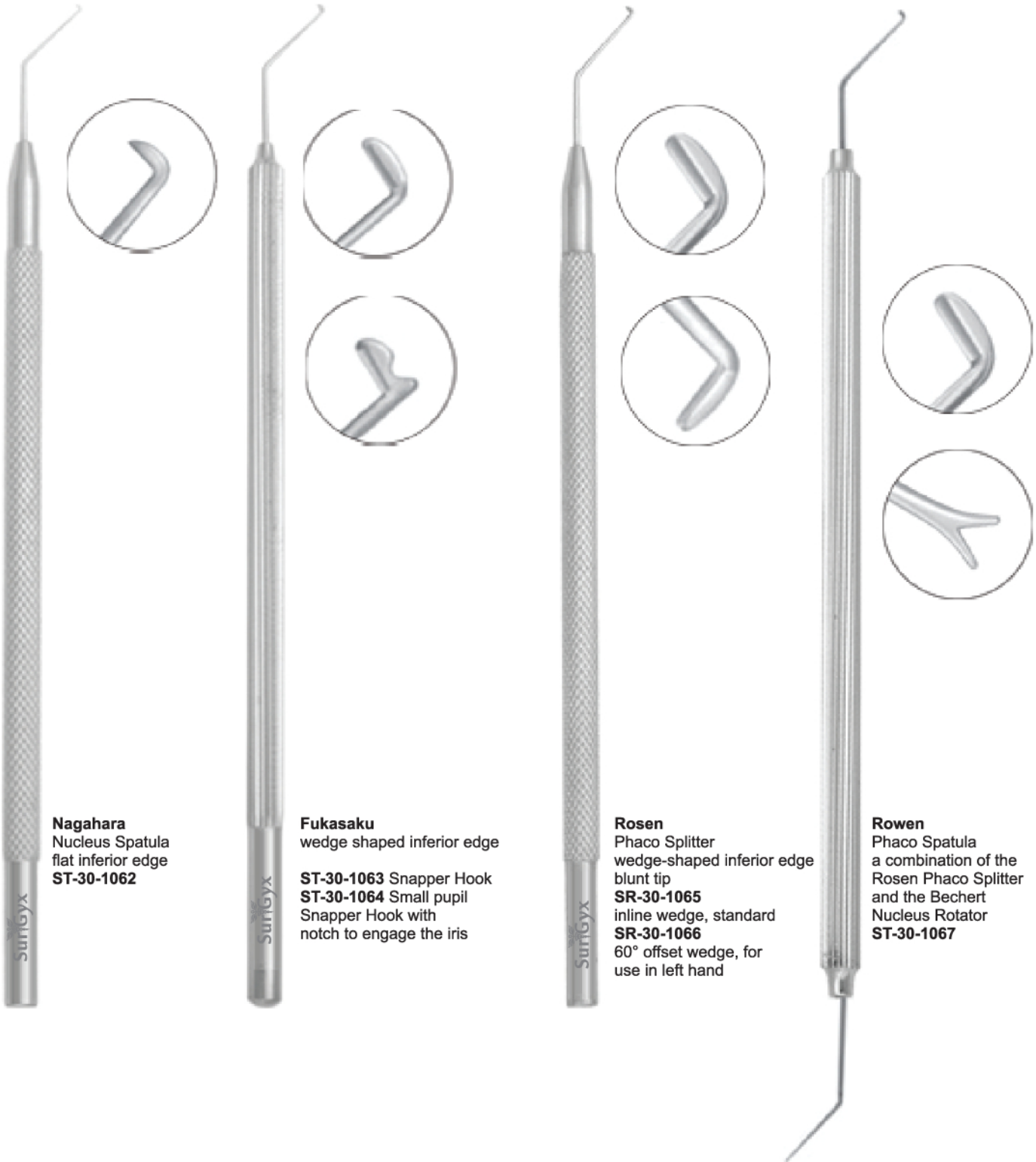

Nagahara
 Nucleus Spatula
 flat inferior edge
ST-30-1062

Fukasaku
 wedge shaped inferior edge
ST-30-1063 Snapper Hook
ST-30-1064 Small pupil
 Snapper Hook with
 notch to engage the iris

Rosen
 Phaco Splitter
 wedge-shaped inferior edge
 blunt tip
SR-30-1065
 inline wedge, standard
SR-30-1066
 60° offset wedge, for
 use in left hand

Rowen
 Phaco Spatula
 a combination of the
 Rosen Phaco Splitter
 and the Bechert
 Nucleus Rotator
ST-30-1067



Bechert
 Nucleus Rotator
 blunt forked tip
ST-30-1068 angled at 7mm
ST-30-1069 angled at 9mm



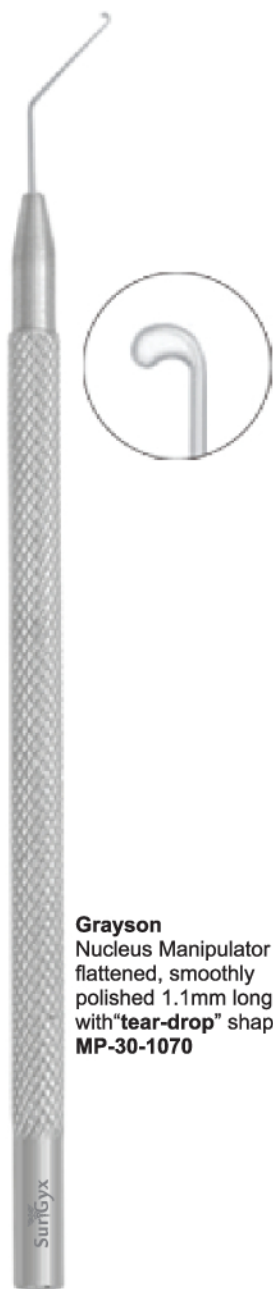

Grayson
 Nucleus Manipulator
 flattened, smoothly
 polished 1.1mm long
 with "tear-drop" shaped tip
MP-30-1070



Drysdale
 Nucleus Manipulator
 paddle shaped tip
MP-30-1071
 rounded edges
MP-30-1072
 defined anterior
 edge for capsule polishing



Pisacano
 Nucleus Rotator
 flat disc shaped tip
MP-30-1073 horizontal
MP-30-1074 horizontal



Siepser
 Endocapsular Controller
 trumpet shaped tip
MP-30-1075



Anis
 Nucleus Manipulator
 with 0.5mm diameter ball tip
MP-30-1076 straight
MP-30-1077 angled

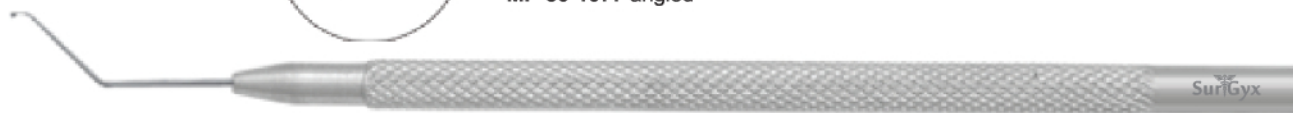

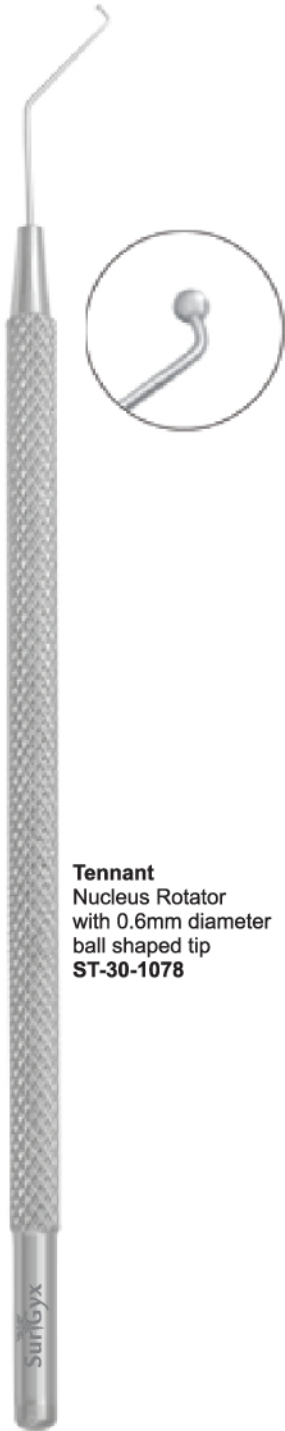

Tennant
Nucleus Rotator
with 0.6mm diameter
ball shaped tip
ST-30-1078



Lippman
Nucleus Spatula
0.5mm diameter round
shaft with blunt forked tip
ST-30-1079



Girard
Synechia Spatula
0.5mm wide with
semi-sharp tip
ST-30-1080



Obstbaum
Synechia Spatula
0.25mm wide with
semi-sharp tip
ST-30-1081



Benedetto
Spatula 10mm long,
smoothly polished
flattened spatula
with beveled notches
ST-30-1082





Moran
 LASIK Enhancement
 Spatula Fukasaku
 spatula and a
 modified Paton
 spatula
ST-30-1088



Hersh
 Flap Spatula
 beveled tips
 a combination of a
 6mm spatula and
 a 10mm spatula
ST-30-1084



Binder
 Flap Elevator
 1mm wide
 12mm long
 semi-sharp edges
ST-30-1085

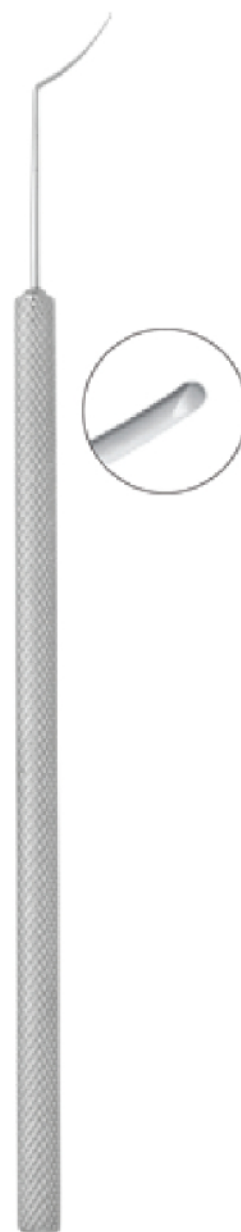

Fukasaku
 LASIK Spatula
 rounded anterior and
 flat posterior surface
 with beveled tip
 For lifting and
 dissecting the corneal flap.
ST-30-1086



Guimaraes
 LASIK Spatula
 gently curved, bi-convex
 semi-sharp edges
ST-30-1087





Katzan
LASIK Flap "Unzipper"
combines a modified
Sinskey Hook and
abi-convex spatula with
beveled notches
For LASIK enhancements.
ST-30-1088



Maddox
LASIK Spatula
combines a flat spatula
and a cylindrical spatula
For elevating and
repositing the flap.
ST-30-1089

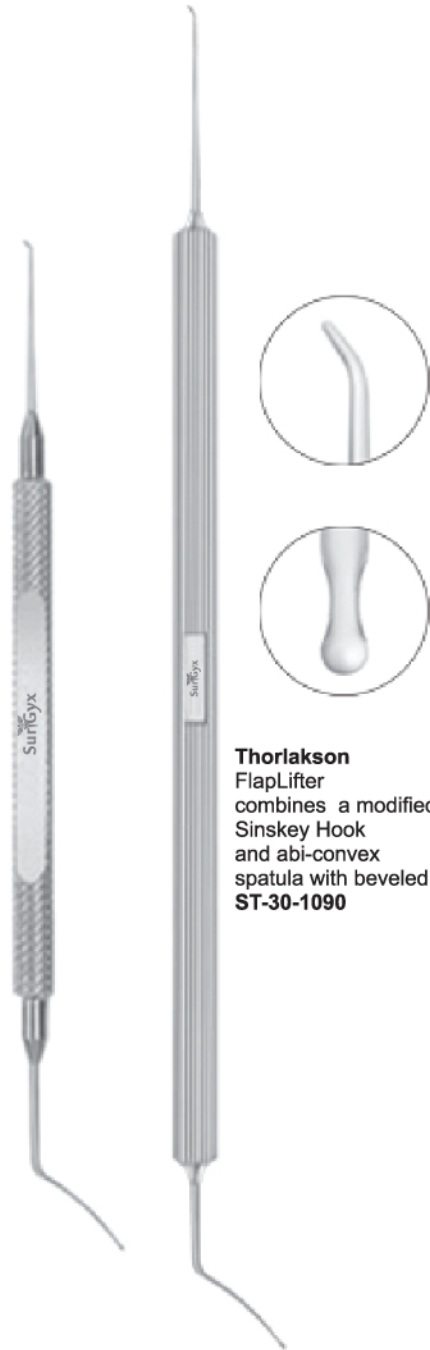

Thorlakson
FlapLifter
combines a modified
Sinskey Hook
and abi-convex
spatula with beveled notches
ST-30-1090



LasikFlapLifter
Combines a 45° angled
Sinskey Hook
and a thin hook with
a conical tip
ST-30-1091



Hirschman
Lens Spatula
flat 0.5mm wide
with multiple notches
ST-30-1092



Jaffe
 Lens Spatula
 flat, 0.5mm wide
 MP-30-1093

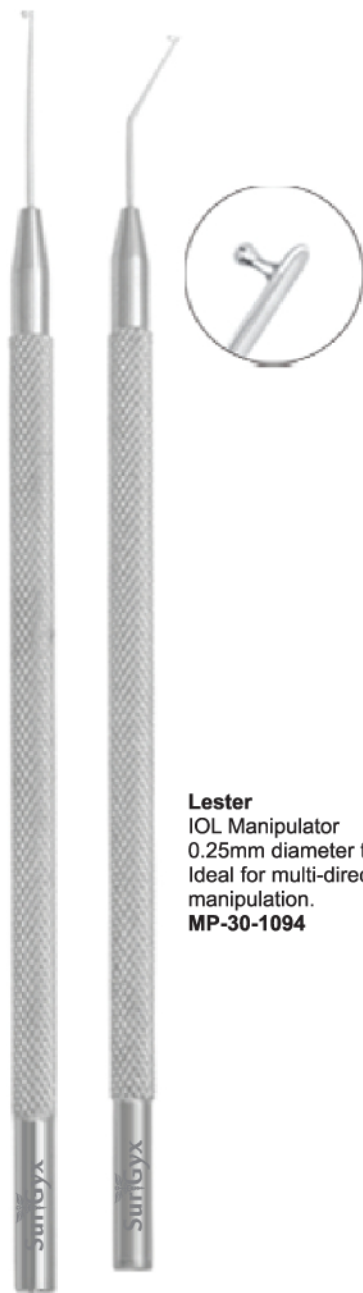

Lester
 IOL Manipulator
 0.25mm diameter tip
 Ideal for multi-directional
 manipulation.
 MP-30-1094

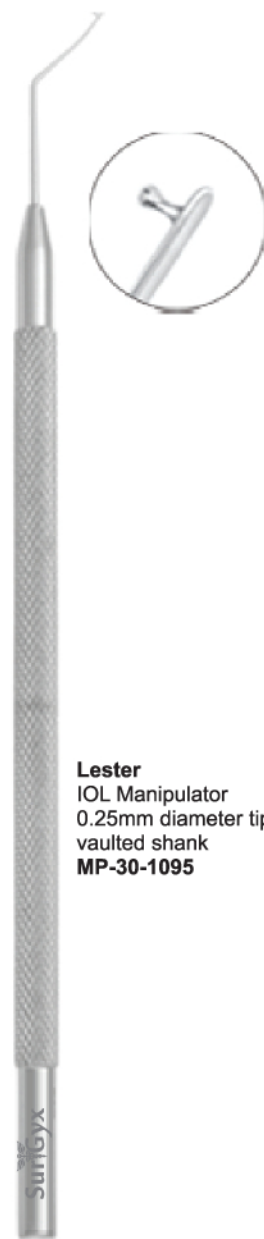

Lester
 IOL Manipulator
 0.25mm diameter tip
 vaulted shank
 MP-30-1095



Maloney
 IOL Manipulator
 0.25mm diameter tip
 vaulted shank
 with guard
 MP-30-1096



Hunkeler
 IOL Manipulator
 with 0.3mm diameter hemi-balltip,
 vaulted shank
 MP-30-1097



Alio-Kelman
 IOL Hook
 0.2mm diameter tip
MP-30-1098



Aker
 Lens Pusher
 smooth, fish mouth
 shaped tip with guard
MP-30-1099

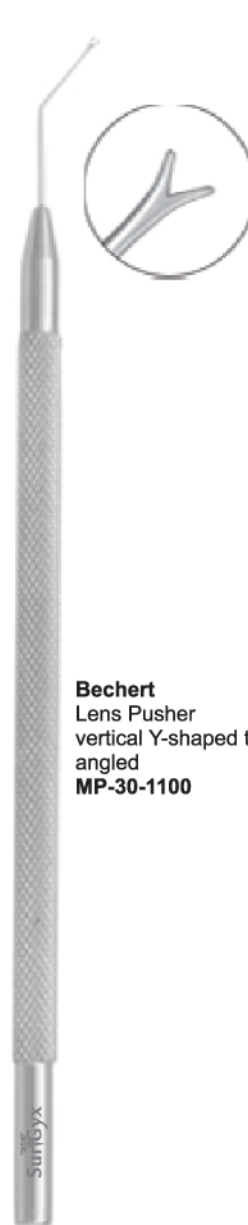

Bechert
 Lens Pusher
 vertical Y-shaped tip
 angled
MP-30-1100



Elsching
 Cyclodialysis Spatula
 flat, 1mm wide
ST-30-1101



Castroviejo
 Synechia Spatula
 0.5mm wide with
 semi-sharp tips
ST-30-1102



Castroviejo
Cyclodialysis Spatula

ST-30-1103 0.25mm wide
ST-30-1104 0.5mm wide



Kimura
Platinum Spatula
ST-30-1105



Keener
Lens Divider
with three
preformed
snare wire loops
ST-30-1106
complete
ST-30-1107
wire loops



LensLoop
ST-30-1108 Lewis, small
ST-30-1109 Lewis, Large
ST-30-1110 New Orleans
ST-30-1111 Wilder, serrated



ST-30-1109



ST-30-1110



ST-30-1111



Kirby
Lens Loop and
Muscle Hook
ST-30-1112



Morrison
 Lens Loop and
 Probe
 ST-30-1113



SurGyx



SurGyx

Lens Loop
 serrated, 3mm wide
ST-30-1114
 Kansas, light curve
ST-30-1115
 Keener-Art,
 strong curve



SurGyx

Alfonso
 Cutting Platform
 Used as a cutting
 block for nucleus
 trisector.
ST-30-1116
 2mm wide
ST-30-1117
 3mm wide



SurGyx

Alfonso
 Nucleus Capture Spoon
ST-30-1118

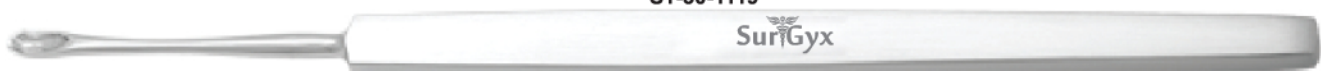

Culler
 Lens Spoon
 sterling silver
ST-30-1119

SurGyx



Paton
 Spatula & Spoon
 For corneal
 button transfer.
ST-30-1120



Bunge
 Evisceration Spoon
ST-30-1121 small
ST-30-1122 large



Wells
 Enucleation Spoon
ST-30-1123



Graether
 Collar Button
 micro iris retractor
ST-30-1124
 straight, with guard
ST-30-1125
 angled



Graether
 Irrigating Collar Button
 micro iris retractor and
 posterior capsule polisher
ST-30-1126 straight
ST-30-1127 angled



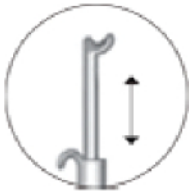

Keuch
Small Pupil Dilator
with guard For enlarging
a small pupil through
the sideport and
primary incision.
HK-30-1128

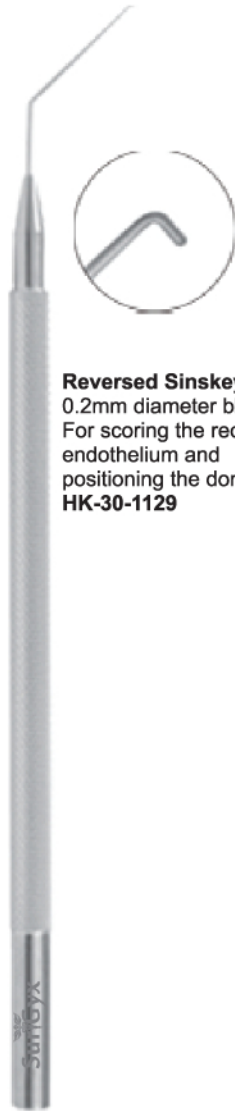

Reversed Sinskey Hook
0.2mm diameter blunt tip
For scoring the recipient
endothelium and
positioning the donor lamella.
HK-30-1129



Bonn
Micro Iris Hook
extra delicate
blunt, round handle
with guard
HK-30-1130



Bonn
Micro Iris Hook
blunt, flat handle
HK-30-1131



Shepard
Iris Hook
blunt
HK-30-1132



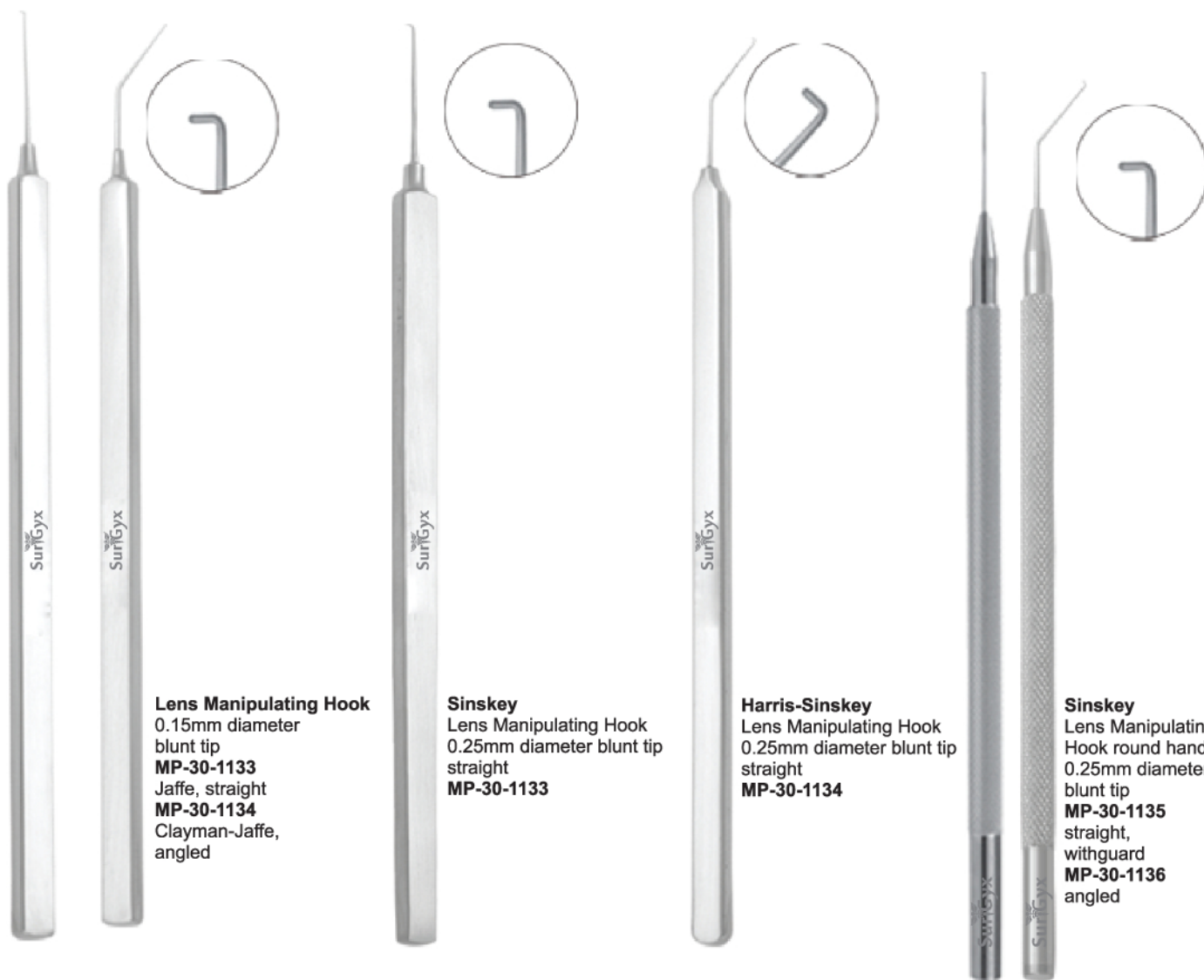

Lens Manipulating Hook
 0.15mm diameter
 blunt tip
MP-30-1133
 Jaffe, straight
MP-30-1134
 Clayman-Jaffe,
 angled

Sinskey
 Lens Manipulating Hook
 0.25mm diameter blunt tip
 straight
MP-30-1133

Harris-Sinskey
 Lens Manipulating Hook
 0.25mm diameter blunt tip
 straight
MP-30-1134

Sinskey
 Lens Manipulating
 Hook round handle
 0.25mm diameter
 blunt tip
MP-30-1135
 straight,
 withguard
MP-30-1136
 angled

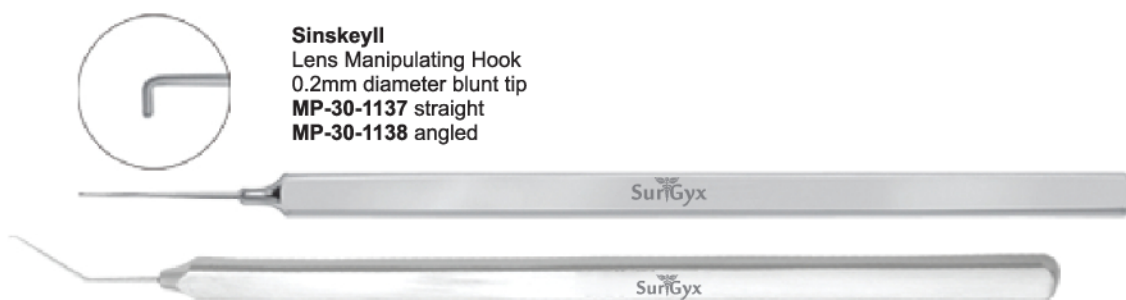

Sinskeyll
 Lens Manipulating Hook
 0.2mm diameter blunt tip
MP-30-1137 straight
MP-30-1138 angled

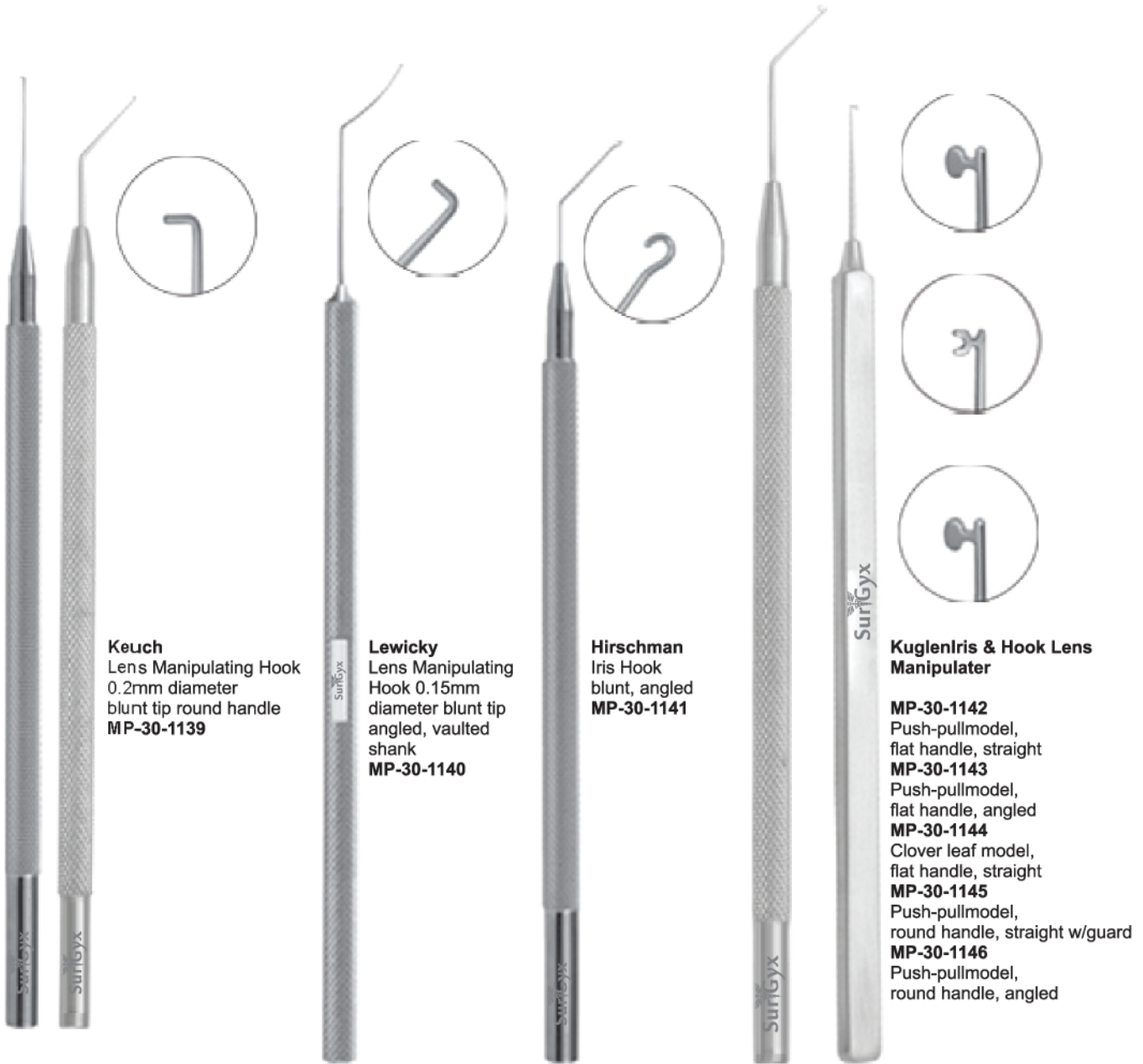

Lens Manipulator
 straight, with guard
MP-30-1147 straight, with guard
MP-30-1148 Osher, Y-hook





Lens Manipulating Hook
 0.15mm diameter tip
HK-30-1149
 Fenzl, round handle
 straight with guard
HK-30-1150
 Fenzl, round handle, angled
HK-30-1151
 Maltzman-Fenzl, round handle,
HK-30-1152
 Maltzman-Fenzl, round handle,
 angled
HK-30-1153
 Jaffe-Maltzman, flat handle, angled



Fixation Hook
 double, sharp
HK-30-1155
HK-30-1156



Twist Hook
 for scleral fixation
HK-30-1157

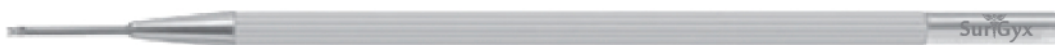

Silverman
 Fixation Pick
 blunt cone shaped tips
 spaced 3mm apart
 for atraumatic scleral fixation
HK-30-1158





Surgenius
Globe Fixation Ring
with concentric grooves
RN-30-1159
for refractive procedures
RN-30-1160
for cataract procedures



Lu-Mendez
LRI Guide and Fixation Ring
with delicate blunt teeth
marks 10° increments
11mm I.D.
RN-30-1161



Gimbel
Stabilization Ring
with swivel handle
13mm diameter with blunt
teeth on both sides
For stabilizing either the
right or left eye during
LASIK.
RN-30-1162



Fine-Thornton
Swivel Fixation Ring
blunt teeth Features marks on anterior
surface in 15° increments
as a guide for placement of
limbal relaxing incisions.
RN-30-1163
13mm diameter
RN-30-1164
16mm diameter



Thornton
Globe Fixation Ring
multiple blunt teeth
16mm diameter ring
RN-30-1165



Hofmann-Thornton
Globe Fixation Ring
with swivel handle
16mm diameter ring
multiple blunt teeth
RN-30-1166



Stevens
Tenotomy Hook
blunt, small
HK-30-1167



Helveston
"Teaser" Hook
extra delicate, blunt
HK-30-1168

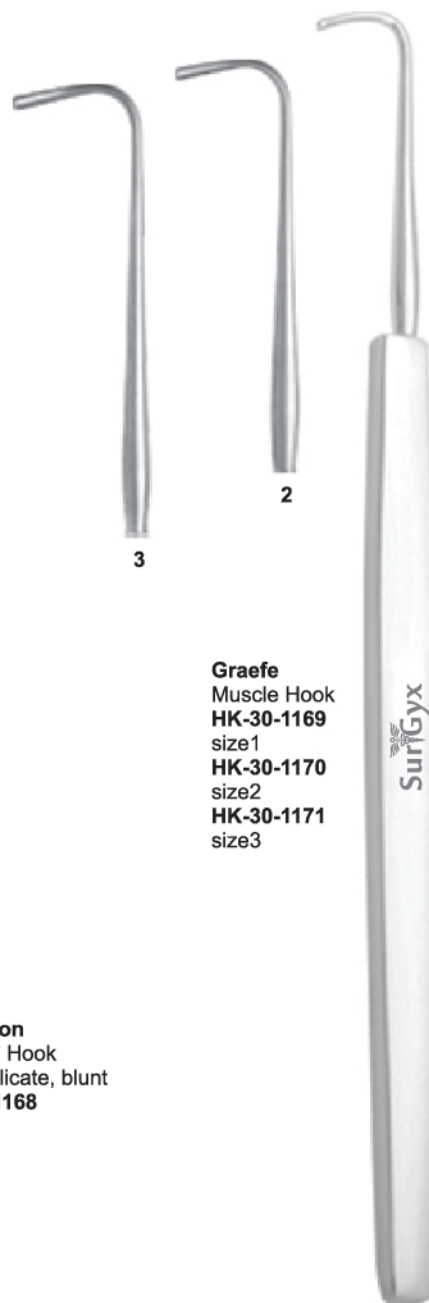

Graefe
Muscle Hook
HK-30-1169
size1
HK-30-1170
size2
HK-30-1171
size3

Gass
Retinal Detachment Hook
with oval hole
HK-30-1172





Helveston
Muscle Hook
extra delicate, with blunt
spatulated tip
HK-30-1174 8mm
HK-30-1175 10mm
HK-30-1176 12mm

Helveston
Muscle Hook
extra delicate, with blunt
spatulated tip
HK-30-1173

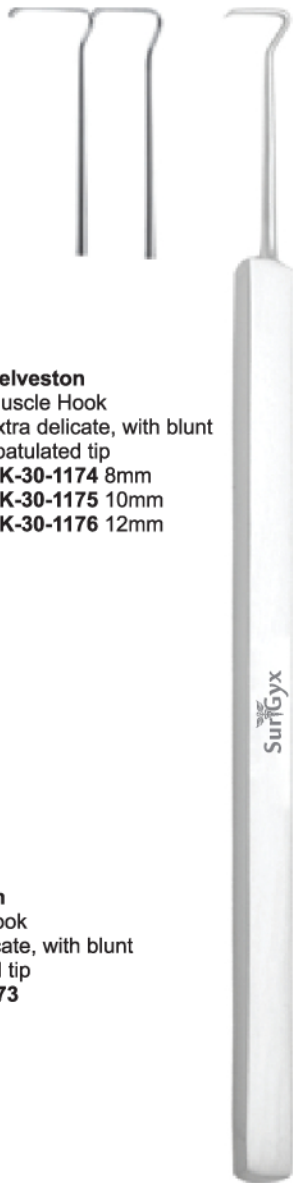

Jameson
Muscle Hook
HK-30-1177 small
HK-30-1178 large



Du Plessis
Muscle Hook
double arm
HK-30-1179



Guyton
Small Incision
Muscle Hook
HK-30-1180





Green
Muscle Hook
HK-30-1181



Naghara
Nucleus Chopper
CH-30-1182



Christensen
Punctum Punch
1mm wide bite
For opening stenotic punctums.
PN-30-1183



Fukasaku
Micro Trabeculectomy Punch
0.6mm diameter head
with bullet shaped tip
0.3mm x 0.6mm deep bite
PN-30-1184



Maloney
Intra-Operative Keratometer
titanium For qualitative
measurement of astigmatism.
KM-30-1185

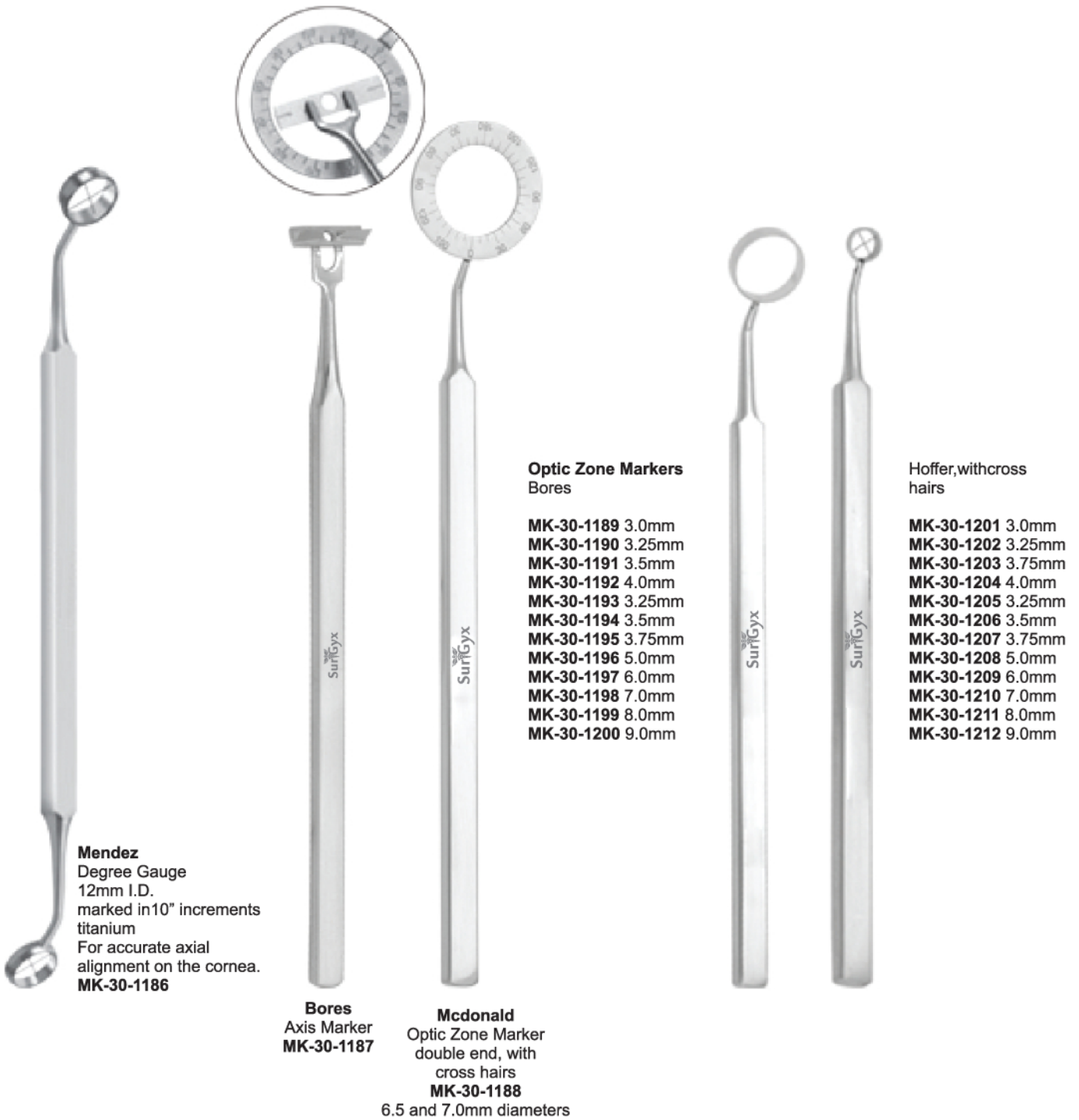

Mendez
 Degree Gauge
 12mm I.D.
 marked in 10° increments
 titanium
 For accurate axial
 alignment on the cornea.
MK-30-1186

Bores
 Axis Marker
MK-30-1187

Mcdonald
 Optic Zone Marker
 double end, with
 cross hairs
MK-30-1188
 6.5 and 7.0mm diameters

Optic Zone Markers
 Bores

- MK-30-1189** 3.0mm
- MK-30-1190** 3.25mm
- MK-30-1191** 3.5mm
- MK-30-1192** 4.0mm
- MK-30-1193** 3.25mm
- MK-30-1194** 3.5mm
- MK-30-1195** 3.75mm
- MK-30-1196** 5.0mm
- MK-30-1197** 6.0mm
- MK-30-1198** 7.0mm
- MK-30-1199** 8.0mm
- MK-30-1200** 9.0mm

Hoffer, with cross
 hairs

- MK-30-1201** 3.0mm
- MK-30-1202** 3.25mm
- MK-30-1203** 3.75mm
- MK-30-1204** 4.0mm
- MK-30-1205** 3.25mm
- MK-30-1206** 3.5mm
- MK-30-1207** 3.75mm
- MK-30-1208** 5.0mm
- MK-30-1209** 6.0mm
- MK-30-1210** 7.0mm
- MK-30-1211** 8.0mm
- MK-30-1212** 9.0mm

Anis
 Radial Marker
 4mm diameter
 center opening
 12.5mm O.D.
MK-30-1213 8 blades
MK-30-1214 10 blades
MK-30-1215 12 blades





Anis
 Suture Placement Marker
 8 radial blades
 8mm diameter center opening
 For corneal grafts.
MK-30-1216



Fechtner
 Trabeculectomy Marker
MK-30-1217



Castroviejo
 Caliper
 20mm spread
CL-30-1218 straight
CL-30-1219 angled
CL-30-1220 curved

Osher
 Incision Caliper
 For internal measurement
 of cataract incisions from
 1to10mm.
CL-30-1221



Helveston
 Scleral Ruler
 5mmlong, with notches in 5mm increments
 single marking tooth at tip. For measuring
 and marking the distance from the limbus
 to the location of the muscle reinsertion.
CL-30-1222



Jameson
Caliper
chrome plated
brass
CL-30-1223



Ruler
Stainless Steel
inches and mm
CL-30-1224



Braunstein
Caliper
3.5/4.0mm
Stainless Steel
CL-30-1225



Rosen
Phco Splitter
60° angled wedge
shaped inferior edge
with blunt tip
SR-30-1226
Titanium



Maloney
Intra-Operative
Keratometer titanium
For qualitative measurement
of astigmatism.
KM-30-1227



Castroviejo
 Corneoscleral Scissors
 small blades
SC-40-1001 right
SC-40-1002 left

Castroviejo
 Corneoscleral Scissors
 medium blades
SC-40-1003 right
SC-40-1004 left



Troutman-Castroviejo
 Corneoscleral Scissors
 with stop, small blades
SC-40-1005 right
SC-40-1006 left

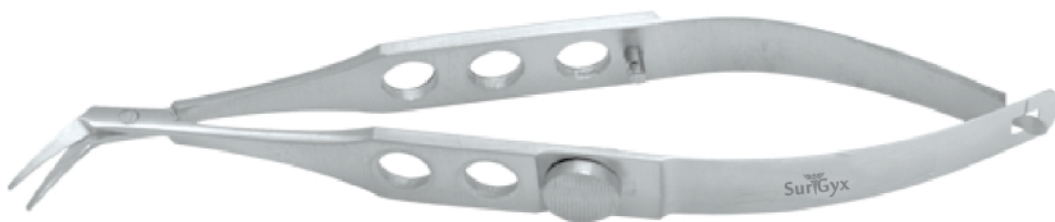

Troutman-Castroviejo
 Corneoscleral Scissors
 with stop, medium blades
SC-40-1007 right
SC-40-1008 left

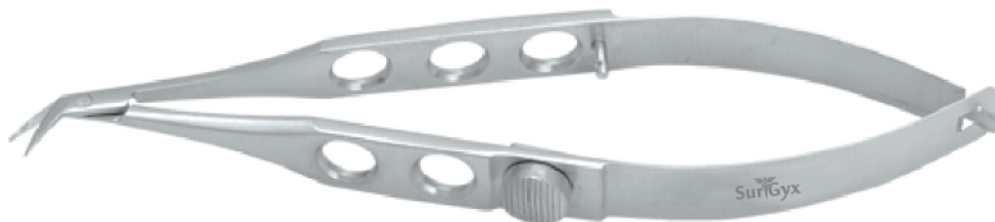

Troutman-Katzin
 Corneal Transplant Scissors
 with stop strong curve,
 small blades
SC-40-1009 right
SC-40-1010 left

Rich

Corneal Transplant Scissors
extremely delicate,
strongly curved blades
For trimming therecipient corneal
bedand donor button.
Canalsobe used for open sky
anterior capsulotomy.
SC-40-1011 right
SC-40-1012 left



Castroviejo

Universal Corneal Scissors
curved, blunttips
SC-40-1015 small blades
SC-40-1016 medium blades
SC-40-1017 large blades
SC-40-1018 stronglycurved
largeblades



Terry

Micro Corneal Scissors
round handle
for meticulous control
SC-40-1013 right
SC-40-1014 left



Katzin

Corneal Transplant Scissors
strong curve, medium blades
SC-40-1019 right
SC-40-1020 left



Castroviejo

Keratoplasty Scissors
angled to side
blunt tips, medium blades
SC-40-1021



McPherson-Westcott
 Conjunctival Scissors
 curved blunt tips, small blades
SC-40-1022



Westcott
 Tenotomy Scissors
 blunt tips, medium blades
 curved
SC-40-1023

Tibolt
 Punctal Scissors
 oneconically shaped blade
 with micro grooves and
 textured surface
 For simple Two-snip
 Punctoplasty.
SC-40-1024



Westcott
 Tenotomy Scissors
 bluntips, standard blades curved
SC-40-1025 right
SC-40-1026 left

Mini Westcott
 Tenotomy Scissors
 4mm long curved blades bluntips
SC-40-1027





McPherson-Westcott
Stitch Scissors
very sharp pointed tips
small blades, curved
SC-40-1028



Westcott
Stitch Scissors
very sharp pointed tips
standard blades curved
SC-40-1029



Jaffe
Stitch Scissors
very sharp pointed tips
medium blades curved
SC-40-1030



Iris
Scissors sharp tips,
small blades
SC-40-1031

Fine
Stitch Scissors
sharp tips, medium blades
SC-40-1032 straight
SC-40-1033 curved





Barraquer
Iris Scissors
blunt tips, 7mm long blades
SC-40-1034



SC-40-1039



SC-40-1036



SC-40-1040



SC-40-1037



SC-40-1041



SC-40-1038



SC-40-1042

Capsulotomy Scissors Vannas

5mm long blades, sharp tips
SC-40-1035 straight
SC-40-1036 curved
SC-40-1037 angled forward
SC-40-1038 angled to side

Gills-Vannas

7mm long blades, sharp tips
SC-40-1039 straight
SC-40-1040 curved
SC-40-1041 angled forward

Mcperson-Vannas

8mm long blades, sharp tips
SC-40-1042 curved

Eye Scissors
pointed tips small
SC-40-1043 straight
SC-40-1044 curved

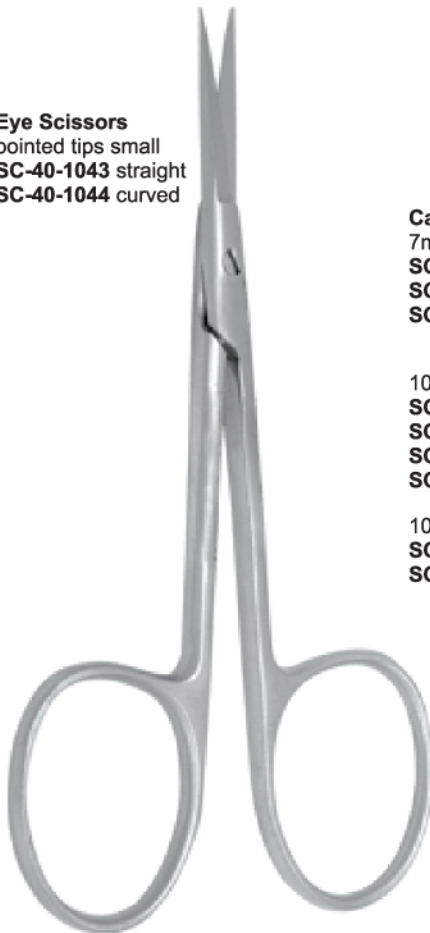

Capsulotomy Scissors Vannas

7mm extra thin long blades, sharp tips
SC-40-1045 straight
SC-40-1046 curved
SC-40-1047 angled forward

10mm extra thin long blades, sharp tips

SC-40-1048 straight
SC-40-1049 curved
SC-40-1050 angled forward
SC-40-1051 curved, angled, forward

10mm long angled blades, curved tips

SC-40-1052 sharp points
SC-40-1053 blunt points



SC-40-1050



SC-40-1046



SC-40-1051



SC-40-1047



SC-40-1052



SC-40-1048



SC-40-1053



SC-40-1049



Eye Scissors
pointed tips
standard

SC-40-1054 straight
SC-40-1055 curved
SC-40-1055 Tungsten Carbide
SC-40-1055 Super Cut



Eye Scissors
large rings
pointed tips
standard

SC-40-1056 straight
SC-40-1057 curved



Stitch Scissors
ribbon type
needle points
curved

SC-40-1058

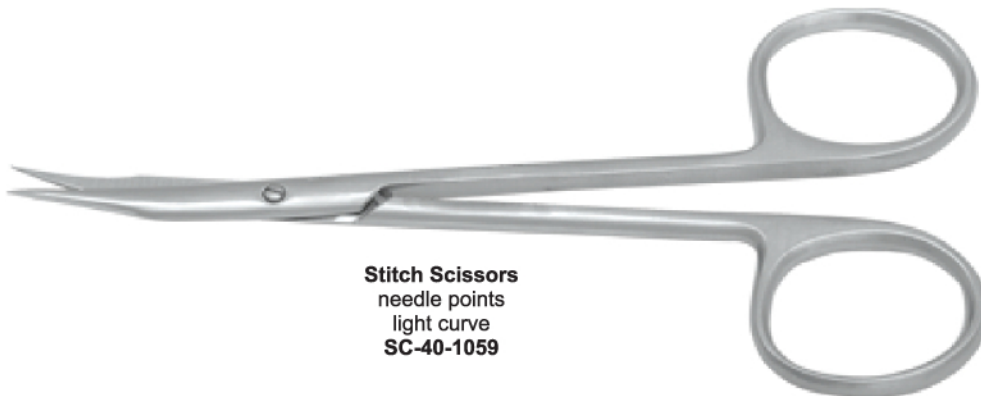

Stitch Scissors
needle points
light curve
SC-40-1059



Stevens
Tenotomy Scissors
blunt tips, standard
SC-40-1060 straight
SC-40-1061 curved



Stevens
Tenotomy Scissors
ribbon type, blunt tips
SC-40-1062 straight
SC-40-1063 curved



Knapp
Strabismus Scissors
blunt tips
SC-40-1064 straight
Tungsten Carbide
SC-40-1065 curved
Tungsten Carbide
SC-40-1066 Straight
SC-40-1067 Curved

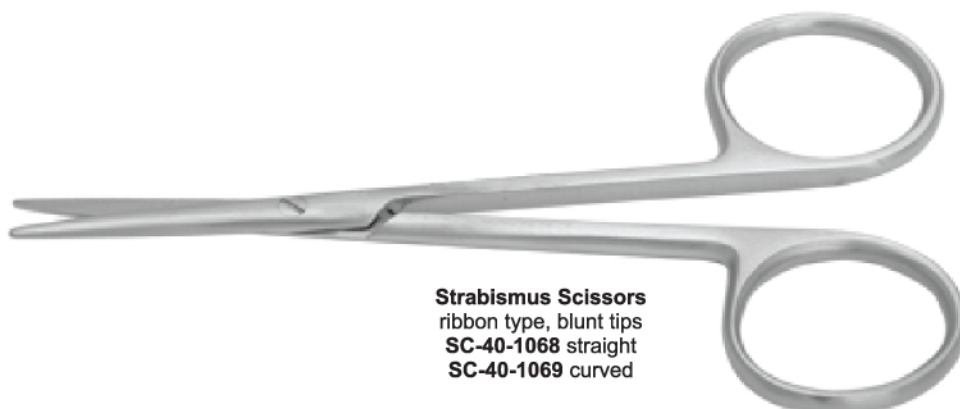

Strabismus Scissors
ribbon type, blunt tips
SC-40-1068 straight
SC-40-1069 curved



Metzenbaum
 Dissecting Scissors
 gently curved blades, blunt tips
 5¾" (14.5cm), long
SC-40-1070



Utility Scissors
 one pointed and one, blunt tip
 5¾" (14.5cm) long, straight
SC-40-1071



Enucleation Scissors
 blunt tips
SC-40-1072 medium curve
SC-40-1073 strong curve



Black Coated Super Cut Scissors
 black coated super cut Iris scissors
SC-40-1074



Vitreotomy Scissors
 T20 gauge shank
 Stainless steel
 construction with
 flat handle.
 Autoclavable.

Scissors
 horizontal opening
 straight
SC-40-1074



Scissors
 horizontal opening
 angled 30°
SC-40-1075



Scissors
 horizontal opening
 angled 60°
SC-40-1076



Scissors
 horizontal opening
 angled 80°
SC-40-1077





Botvin
 Iris Forceps
 For peripheral iridectomies.
FR-50-1001 serrated tips
FR-50-1002 1x2 teeth



FR-50-1003



FR-50-1004



FR-50-1005



FR-50-1006



FR-50-1007



FR-50-1008

Colibri Style

very delicate, 1x2 teeth, 0.12mm

FR-50-1003 Colibri

FR-50-1004 Harms-Colibri, with tying platform

FR-50-1004 Harms-Colibri, titanium, with tying platform

FR-50-1005 Dyson-Colibri, short tips, extremely thin shanks, with tying platform

Standard, 1x2 teeth with tying platform

FR-50-1006 Colibri, 0.4mm

Corneal Suturing Forceps delicate, 1mm spread

FR-50-1007 Polack

Corneal Forceps very delicate, 1x1 teeth, 0.1mm

FR-50-1008 Pierse-Colibri



Gills-Colibri
 Tissue Forceps
 very fine pointed tips
 with tying platform
FR-50-1009



Hoskin
 Tissue Forceps
 very fine pointed tips
 with tying platform
FR-50-1010
 #16, fine grooved tips



FR-50-1011



FR-50-1012



FR-50-1013

Hoskin

Tissue Forceps, straight

FR-50-1011 #18, fine grooved tips

FR-50-1012 #19, micro grooved tips

FR-50-1013 #28, very delicate, micro grooved tips



Hoskin
 Tissue Forceps,
 Colibri style
FR-50-1014 #22, micro grooved tips
FR-50-1015 #30, very delicate micro
 grooved tips
FR-50-1016 #34, pointed tips



Pierse
 Corneal Forceps
 very delicate
 1x1 teeth, 0.1mm
 straight
FR-50-1017



Fechtner
 Conjunctiva Forceps
 very delicate
 ring shaped tips
 with tying platform
FR-50-1018



Castroviejo-Colibri
FR-50-1019 1x2 teeth, 0.12mm
FR-50-1020 Harms 1x2 teeth,
 0.12mm with tying platform
FR-50-1021 Hyde 2x2 teeth,
 0.12mm with tying platform

COLIBRI FORCEPS
 with tying platform
FR-50-1022





Bonn
 French Pattern Bonn Forceps
 0.1mm with tying
FR-50-1023



Bonn
 Forceps
 very delicate
 1x2 teeth, 0.12mm
FR-50-1024



Bonn
 Forceps
 1x2 teeth, 0.12mm
 with tying platform
FR-50-1025



Thorpe
 Corneal Forceps
 2x3 teeth, 0.12mm
 with tying platform
FR-50-1026



Mcpherson
 Tissue Forceps
 1x2 teeth, 0.4mm
 with tying platform
FR-50-1027 straight
FR-50-1028 angled



Kelman-Mcpherson
 Forceps
 8mm long jaws
 1x2 teeth, 0.3mm
 FR-50-1029



Hoffer-Mcpherson
 Forceps very delicate
 11mm long jaws
 1x2 teeth, 0.12mm
 FR-50-1030



Castroviejo Suturing Forceps
 1x2 teeth with tying platform
 FR-50-1031 0.12mm
 FR-50-1032 0.3mm
 FR-50-1033 0.5mm
 FR-50-1034 0.9mm
 FR-50-1035 0.12mm, titanium

Castroviejo Suturing Forceps
 1x2 teeth with tying platform
 FR-50-1036 0.12mm
 FR-50-1037 0.3mm
 FR-50-1038 0.5mm
 FR-50-1039 0.9mm
 FR-50-1040 0.12mm, titanium

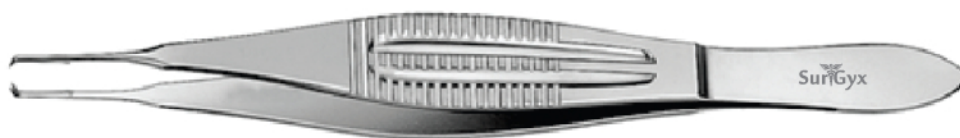

Castroviejo Suturing Forceps
 1x2 teeth with tying platform
 FR-50-1041





Moody
 Fixation Forceps
 1x2 teeth, 0.5mm
 with lock
FR-50-1042



Helveston
 Fixation Forceps
 1x2 teeth, 0.6mm
 For globe fixation
 during strabismus
 procedures.
FR-50-1043



Girard
 Corneoscleral
 Forceps
 1x2 teeth, 0.12mm
 with tying platform
FR-50-1044
FR-50-1045



Mauensee-Colibri
 Corneal Forceps
 very delicate
 1x2 teeth, 0.12mm
FR-50-1046



Bores
 Corneal Fixation Forceps
 U-Shaped, 3mm spread
 1x2 teeth at each tip, 0.12mm
FR-50-1047



Bishop-Harmon
 Tissue Forceps
 1x2 teeth
FR-50-1048 delicate
FR-50-1049 standard



Bishop-Harmon
 Dressing Forceps
 criss-cross serrated tips
FR-50-1050



Fixation Forceps
 1x2 teeth, 0.3mmt
FR-50-1051 Sauer
FR-50-1052 Manhattan
 Eye & Ear, with tying platform

Dressing Forceps
 serrated, delicate
FR-50-1053 straight
FR-50-1054 curved

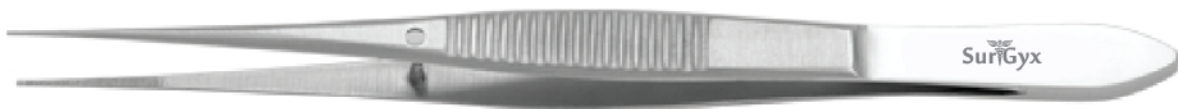

Tissue Forceps
 1x2 teeth
FR-50-1054 delicate, straight
FR-50-1055 delicate, curved
FR-50-1056 standard, straight

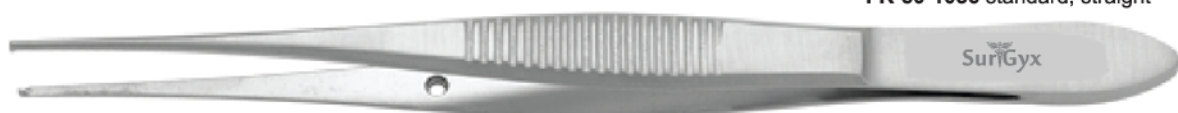



Adson
 straight, 5" (125mm) long
FR-50-1057 Dressing Forceps
 serrated jaws, delicate
FR-50-1058 Dressing Forceps
 serrated jaws, standard
FR-50-1059 Tissue Forceps
 1x2 teeth, delicate
FR-50-1060 Tissue Forceps,
 1x2 teeth, standard



Bayonet
 Dressing Forceps
 serrated jaws
 5 3/4" (146mm) long
FR-50-1061



Lester
 Fixation Forceps
 straight
FR-50-1062
 1x2 teeth
FR-50-1063
 2x3 teeth



Fixation Forceps
 1x2 teeth
FR-50-1064
 Bracken delicate teeth
FR-50-1065
 Elschmig, standard teeth

Troutman
 Superior Rectus Forceps
 1x2 teeth, angled
FR-50-1066



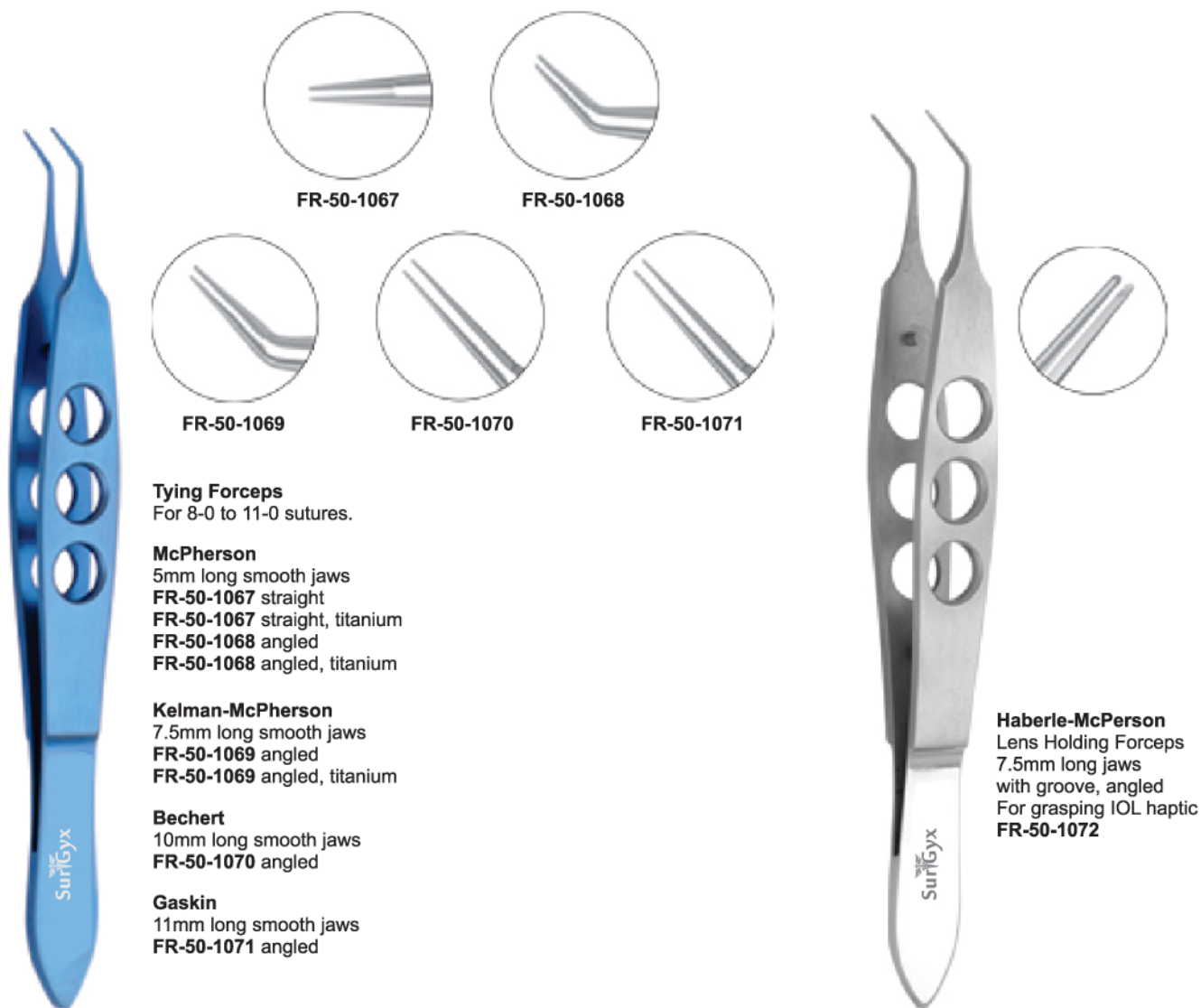

Tying Forceps
For 8-0 to 11-0 sutures.

McPherson
5mm long smooth jaws
FR-50-1067 straight
FR-50-1067 straight, titanium
FR-50-1068 angled
FR-50-1068 angled, titanium

Kelman-McPherson
7.5mm long smooth jaws
FR-50-1069 angled
FR-50-1069 angled, titanium

Bechert
10mm long smooth jaws
FR-50-1070 angled

Gaskin
11mm long smooth jaws
FR-50-1071 angled

Haberle-McPerson
Lens Holding Forceps
7.5mm long jaws
with groove, angled
For grasping IOL haptic
FR-50-1072



Kurstin
Flap Stretching Forceps
disc shaped, serrated jaws
Designed for stretching
the flap to eliminate striae.
FR-50-1073



Buratto
LASIK Flap Forceps
disc shaped, serrated jaws
FR-50-1074



Inamura
Capsulorhexis Forceps
delicate tapered shanks
to seal the incision during
continuous curvilinear
capsulorhexis
Excellent for MICS
FR-50-1075



Utrata
Capsulorhexis Forceps
very delicate, short handle
triangular grasping tips
extremely thin
with landmarks at 2.5mm and
5.0mm
FR-50-1076 straight

Masket
Capsulorhexis Forceps
very delicate, short handle
triangular grasping tips
extremely thin
with landmarks at 2.5mm and
5.0mm
FR-50-1077 vaulted



Kraff
Capsule Tag Forceps
11mm long shanks
1.5mm long grasping tips
FR-50-1078





Utrata
 Capsulorhexis Forceps
 very delicate
 triangular grasping tips
 extremely thin
 11mm long shanks
FR-50-1079 stainless steel
FR-50-1080 titanium



Utrata
 Capsulorhexis Forceps
 very delicate
 triangular grasping tips
 extremely thin
 11mm long shanks
 round handle with guide pin
 for alignment
FR-50-1081



Nevyas
 Capsulorhexis Forceps
 cystotome shaped tips
 extremely thin
 11mm long shanks
 For tearing and grasping
 the anterior capsule.
FR-50-1082



Masket
 Capsulorhexis Forceps
 very delicate
 triangular grasping tips
 extremely thin 11mm long
 vaulted shanks
FR-50-1083



Inamura
 Capsulorhexis Forceps
 round handle
FR-50-1084

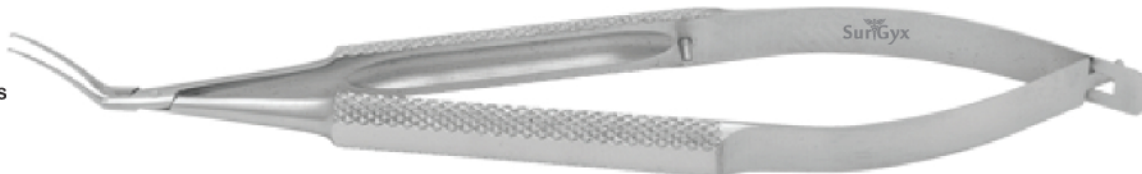



Masket
 Capsulorhexis Forceps
 very delicate
 triangular grasping tips
 extremely thin 11mm long
 vaulted shanks
 round handle with guide pin
 for alignment
FR-50-1085



Utrata
 Capsulorhexis Forceps
 very delicate
FR-50-1086
 stainless steel
FR-50-1086T
 titanium



Kelman McPherson
 French pattern tying Forceps
 11mm
FR-50-1087



McPherson
 tying Forceps
 5mm
FR-50-1088



Adson
 Titanium forceps 5 (125mm)
FR-50-1089



Capsulorhexis Forceps
Roundhandle, curved,
cystitometips, 11.5cm long
FR-50-1090



Capsulorhexis Forceps
Corydonforceps: Ergonomic,
curved, cystitometips,
11.5 cm long
FR-50-1091



BONN Corneal Forceps
delicate, 1x2 straight,
0.12mm teeth,
with tying platform
FR-50-1092



Corneal Forceps
delicate, 1x2 straight,
0.12 mm teeth, with tying
platform, ergonomic handle
FR-50-1093

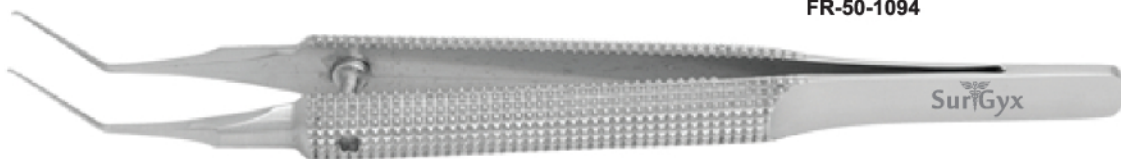

Capsulorhexis Forceps
Round handle
11mm long shanks
FR-50-1094



Colibri Corneal Forceps
 1x2 straight, 0.10mm teeth,
 with tying platform, titanium
FR-50-1095



Corneal Forceps
 delicate, 1x2 oblique,
 0.10mm teeth, with tying
 platform,
 ergonomic handle,
 titanium
FR-50-1096



Corneal Forceps
 delicate, 1x2 straight,
 0.10mm teeth,
 with tying platform, titanium
FR-50-1097

straight, 0.30mm
 Piercetips, with tying platform,
 titanium
FR-50-1098



Capsulorhexis forceps
 for micro coaxial phaco
 with 2mm controlled opening,
 for 2mm incisions
FR-50-1099



MICS/MCCS Capsulorhexis Forceps
 with 2mm controlled opening,
 for 2mm incisions
 FR-50-1100



23G, MICS/MCCS Coaxial Capsulorhexis Forceps
 1.3mm jaws, for 1mm incisions,
 titanium
 FR-50-1101



Capsulorhexis Forceps
 angled, 12mm, graduated,
 slightly curved arms, sharp tips,
 ergonomic handle
 FR-50-1102

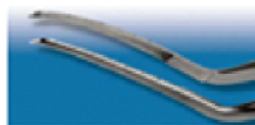

Capsulorhexis Forceps
 very fine, angled,
 11mm, graduated, slightly curved arms,
 sharp, strongly angled tips,
 ergonomic handle
 FR-50-1103



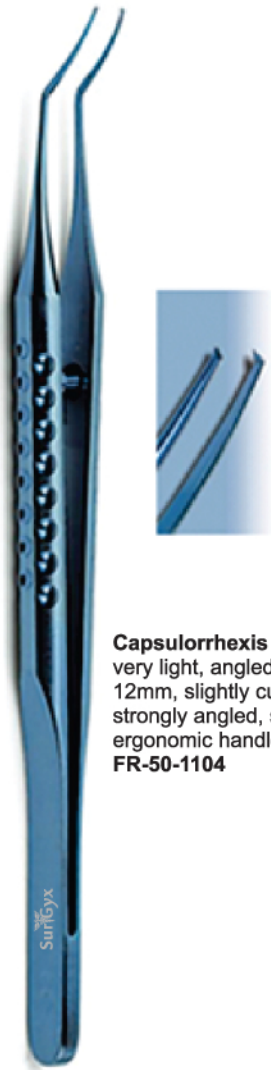

Capsulorhexis Forceps
very light, angled,
12mm, slightly curved arms,
strongly angled, sharp tips,
ergonomic handle, titanium
FR-50-1104



Prechopper
cross action,
2mm opening, sharp top side,
ergonomic handle,
Combo Prechopper,
for grades 1-4 nuclei,
2mm opening, sharp top side
FR-50-1105



Acrylic IOL folder
cross action,
ideal for 5.5 and 6.0mm
foldable
FR-50-1106



Forces
angled, with 11mm tying platform,
ergonomic handle
FR-50-1107



Tying Forceps
curved, with 7mm tying platform,
very delicate, ergonomic handle
FR-50-1108



Forceps
angled, with 9mm tying
platform, titanium
FR-50-1109



Tying and Stitch Forceps
straight, with
6mm tying platform,
delicate Ideal for 8-0
to 10-0 sutures
FR-50-1110



Jaffe
Capsulorhexis Forceps
very delicate
round grasping tips
extremely thin
11mm long shanks
FR-50-1111



Sinskey
Tying Forceps
very delicate
smooth jaws
For 8-0 to 11-0 sutures.
FR-50-1112



Anis
Tying Forceps
extra delicate
smooth jaws
For 9-0 to 11-0 sutures.
FR-50-1113



Freeman-Jaffe
Lens Holding Forceps
with longitudinal groove
For grasping IOL haptic.
FR-50-1114



Jaffe
Tying Forceps
very delicate
smooth jaws
6mm long platform
For 8-0 to 11-0 sutures.
FR-50-1115

Gerl
Tying Forceps
curved shanks
6mm long platform
For 8-0 to 11-0 sutures.
titanium
FR-50-1116



Tennant
Tying Forceps
extra delicate smooth jaws
with 6mm long platform
round handle with guide pin
For 9-0 to 11-0 sutures.
FR-50-1117 straight
FR-50-1118 straight, titanium
FR-50-1119 curved
FR-50-1120 curved, titanium

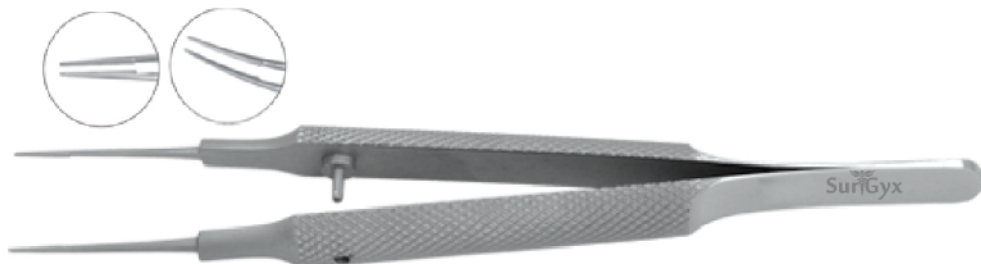



Maumenee
Tying Forceps
concave-convex jaws
round handle with guide pin
For 8-0 to 11-0 sutures.
FR-50-1121 straight titanium
FR-50-1122 angled titanium
FR-50-1123 straight
FR-50-1124 angled



Harms
Tying Forceps
standard, smooth jaws
for 7-0 to 9-0 sutures.
FR-50-1125 straight
FR-50-1126 curved



Helveston
Tying Forceps
standard, smooth jaws
For 4-0 to 6-0 sutures.
FR-50-1127



Fine
Tying Forceps
standard, smooth jaws
For 7-0 to 9-0 sutures.
FR-50-1128



Arita
 Meibomian Gland
 Compressor broad,
 smoothly polished jaws
FR-50-1129



Barraquer
 Cilia Forceps
 lightly angled
 Textured jaws provide
 superior grasping
 capabilities.
FR-50-1130



Gradle
 Cilia Forceps
 smooth jaws
FR-50-1131

Cilia Forceps
 Cilia Forceps
 slanted jaws
 gold plated
FR-50-1132



Bonaccolto
 Conjunctiva Forceps
 longitudinally serrated jaws
 with cross serrations at tips
FR-50-1133 1.2mm wide
FR-50-1134 1.7mm wide





Nugent
 Utility Forceps
 FR-50-1135 smooth jaws

Gold
 Punctal Plug Forceps
 0.2mm wide longitudinal
 groove inside jaws
 pointed tips
 FR-50-1136

Foreign
 Body Forceps
 straight
 FR-50-1137

Utility & Splinter
 Forceps
 pointed, short jaws
 Suitable for epilation.
 FR-50-1138



**Jewelers
Forceps**
standard, straight
FR-50-1139



**Jewelers
Forceps**
delicate, straight
FR-50-1140



**Jewelers
Forceps**
delicate, straight
FR-50-1141



**Jewelers
Forceps**
delicate, straight
FR-50-1142



**Jewelers
Forceps**
delicate, straight
FR-50-1142



Osher
 Iris Forceps
 very fine textured
 jaws, angled
FR-50-1143



Jewelers
 Forceps
 extra delicate,
 angled
FR-50-1144



Jewelers
 Forceps
 curved
FR-50-1145



Suture
 Removal Forceps
 very fine pointed tips
 with textured jaws
 Ideal for grasping wet
 sutures.
FR-50-1146



Jaffe
 Utility Forceps
 very delicate smooth jaws, curved
FR-50-1147



Arruga
 Capsule Forceps
FR-50-1148

Akahoshi
 Phaco PreChopper
 4.5mm long delicate jaws
 with sharp tips
 For cracking, dividing and rotating
 the nucleus without sculpting.
FR-50-1149



Akahoshi
 Combo PreChopper
 For cracking, dividing and rotating
 both hard and soft nuclei without
 sculpting.
FR-50-1150

Ernest
 Nucleus Cracker
 extra delicate cross-action
 serrated paddle tips
 For cracking the nucleus
 through a 2.5mm incision.
FR-50-1151



Ernest
 Micro Nucleus Cracker
 extra delicate cross-action
 serrated paddle tips
 For cracking the nucleus
 through a 2mm incision.
FR-50-1152



Dodick
 Nucleus Cracker
 cross-action
 longitudinally serrated
 paddle shaped jaws
 For cracking the nucleus
 through a 3mm incision.
FR-50-1153



Hu Femto Forceps
 Blunted 0.3mm tips
 cross-action mechanism
 For opening incisions
 created with a
 femtosecond laser.
FR-50-1154



Alfonso
 Nucleus Grasping Forceps
 two short rows of
 delicate interlocking teeth
 For grasping and extracting
 nucleus fragments.
FR-50-1155

Vitreo-Retinal Forceps
 stainless steel with
 stainless steel handle



Smooth Jaws
 20 gauge, straight
FR-50-1156



Serrated Jaws
 20 gauge, straight
FR-50-1157

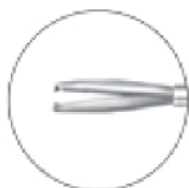

Smooth Jaws, 1x2teeth
 20 gauge, straight
FR-50-1158



Smooth Jaws
 end gripping
 20 gauge, straight
FR-50-1159



Smooth Jaws
 20 gauge, vertical
FR-50-1160



Endothelial Grasping Forceps
 curved, 23 gauge
 delicate end-gripping
 platforms jaws 90°
 off-set from "squeeze handle"
 mechanism
FR-50-1161



Vitreoretinal Forceps
 Lens Cartridge
 Loading Forceps
 straight, 20 gauge
FR-50-1162



Alio Forceps
 MICS Capsulorrhexis
 Forceps 23 gauge
 curved shaft with
 micro grasping tips
FR-50-1163



Fine-Ikeda
 MICS Capsulorrhexis
 Forceps 23 gauge
 curved shaft with
 short micro-grasping
 tips
FR-50-1164



Dodick
 IOL Folding Forceps
 For soft IOLs.
FR-50-1165





Livernois
 IOL Folding Forceps
 concave jaws surfaces
 For soft IOLs.
FR-50-1166



Livernois
 IOL Holding Forceps
 highly polished round jaws
 For holding a soft IOL
 while folding with an
 inserting forceps.
FR-50-1167 straight
FR-50-1168 angled

Steinert
 IOL Inserting Forceps
 conically shaped jaws
 with flat inside surfaces
 Used for folding and
 inserting soft IOLs.
FR-50-1169



Livernois-McDonald
 IOL Inserting Forceps
 5mm long concave jaws
 patented cross-action
 For inserting silicone IOLs.
FR-50-1170





Ernest-McDonald
 IOL Inserting Forceps
 5mm long straight jaws
 low profile patented
 cross-action For
 inserting silicone IOLs.
FR-50-1171



Ernest-McDonald III
 Lens Cartridge
 Loading Forceps
 straight, 20 gauge
 jaws feature a series
 of concave and
 convex surfaces
FR-50-1172



Faulkner
 Lens Holding Forceps
 round, smooth jaws
 For holding soft IOLs.
FR-50-1173

Buratto
 Soft IOL Inserting
 Forceps extra
 delicate highly
 polished convex
 jaws For foldable
 acrylic and
 silicone IOLs.
FR-50-1174



Spaleck
 Soft IOL Inserting Forceps
 delicate highly polished
 convex jaws For foldable acrylic and
 silicone IOLs.
FR-50-1175





Ernest-McDonald
 IOL Inserting Forceps
 polished bi-convexjaws
 patented cross-action
 For acrylic IOLs.
FR-50-1176

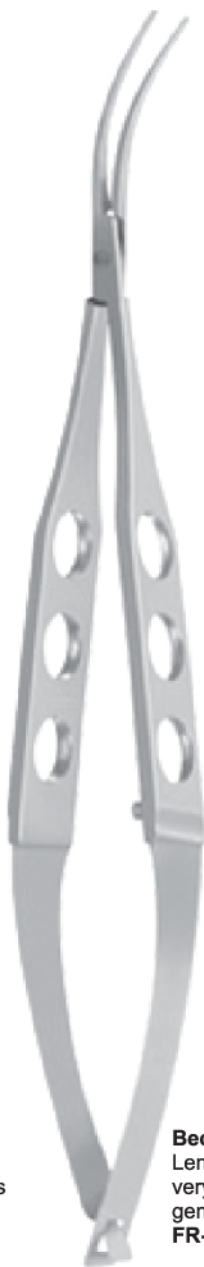

Bechert
 Lens Holding Forceps
 very delicate flat jaws
 gently curved
FR-50-1177

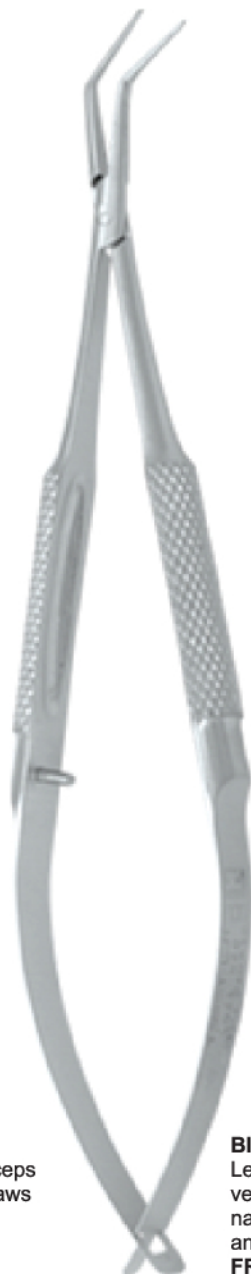

Blaydes
 Lens Holding Forceps
 very delicate
 narrow jaws
 angled 45°
FR-50-1178

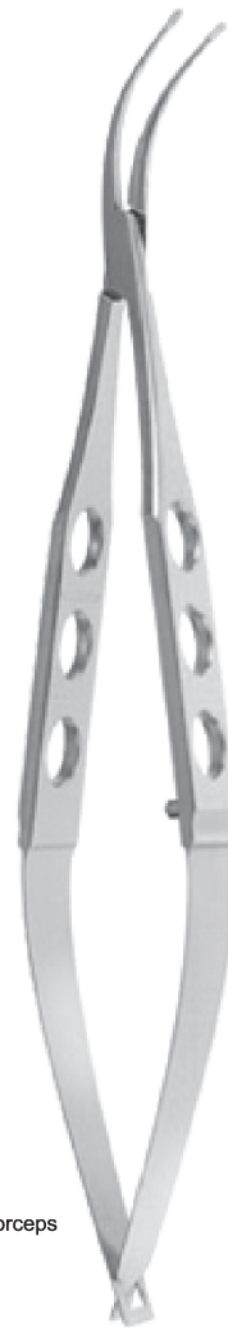

Shepard
 Lens Holding Forceps
 duckbill shaped jaws
 gently curved
FR-50-1179



Clayman
 Lens Holding Forceps
 delicate angled jaws
 gently curved
FR-50-1180



Jameson
 Muscle Forceps
 with slide lock
FR-50-1181 4 teeth, childsize, right
FR-50-1182 4 teeth, childsize, left
FR-50-1183 6 teeth, childsize, right
FR-50-1184 6 teeth, childsize, left



Chalazion Forceps
 round
FR-50-1185
 Lambert, 8mm I.D.
FR-50-1186
 Hunt, 12mm I.D.



Chalazion Forceps
 oval
FR-50-1187
 Baird, 11 x 8mm I.D. small
FR-50-1188
 Francis, 14 x 11mm I.D. medium
FR-50-1189
 Desmarres, 20 x 13mm I.D. large



Serrefine
 serrated jaws, small
 1 1/2" (38mm) long
FR-50-1190

Hartmann
 Mosquito Forceps
 extra delicate
 3 3/4" (95mm) long
FR-50-1191 straight
FR-50-1192 curved

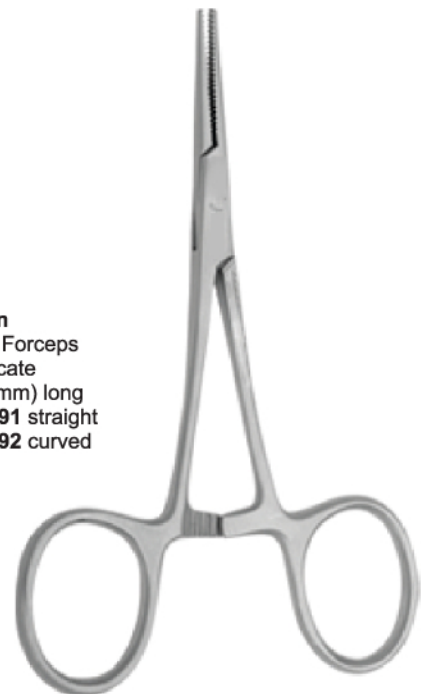



Halsted
Mosquito Forceps
delicate
53/4" (145mm) long
FR-50-1193 straight
FR-50-1194 curved



Baby Jones
Towel Clamp
cross-action
21/4" (55mm) long
FR-50-1195



Backhaus
Towel Clamp
FR-50-1196 34/2" (90mm)
FR-50-1197 51/4" (135mm)
FR-50-1198 34/2" (90mm), titanium
FR-50-1199 51/4" (135mm), titanium

Desmarres Forceps
oval
FR-50-11200 25mm





Castroviejo
 Suturing Forceps
 1x2 teeth
 with tying platform
FR-50-1201
 0.5mm Titanium



McPherson
 Tying Forceps
 5mm long smooth jaws
 straight
FR-50-1202
 Titanium



Kelman-McPherson
 Forceps
 5mm long smooth jaws
 angled
FR-50-1203
 Titanium



Utrata
 Capsulorhexis Forceps
 triangular grasping tips
 11mm long shanks
FR-50-1204
 Titanium



Colibri
 Forceps
 extra delicate
 1x2 teeth, 0.12mm
 with tying platform
FR-50-1205



McPherson
 Needle Holder
 very delicate jaws
NH-60-1001 with lock straight
NH-60-1002 without lock straight
NH-60-1003 with lock curved
NH-60-1004 without lock curved



Jaffe
 Needle Holder
 delicate conical jaws
NH-60-1005 with lock straight
NH-60-1006 with lock curved
NH-60-1007 without lock curved



Castroviejo
 Needle Holder
 delicate jaws, straight
NH-60-1008 with lock
NH-60-1009 without lock

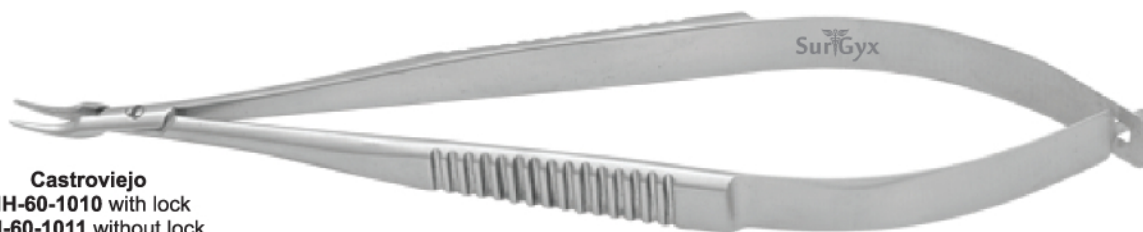

Castroviejo
NH-60-1010 with lock
NH-60-1011 without lock



Castroviejo
 Needle Holder
 delicate jaws, curved
NH-60-1012 with lock
NH-60-1013 without lock



Castroviejo
 Needle Holder
 standard jaws
 straight, with lock
NH-60-1014
NH-60-1015 TC Tungsten Tip



Castroviejo
 Needle Holder
 standard jaws
 curved, with lock
NH-60-1016



Drews
 Needle Holder
 extra delicate jaws
 straight, with lock
NH-60-1018 straight, with lock
NH-60-1019 straight, without lock
NH-60-1020 curved, with lock
NH-60-1021 curved, without lock

Kalt
 Needle Holder
 delicate smooth jaws
 straight, with lock
NH-60-1017





Castroviejo
Needle Holder
delicate jaws titanium
NH-60-1022 with lockstr
NH-60-1023 with lock cvd
NH-60-1024 without lock cvd
NH-60-1025 without lock standard

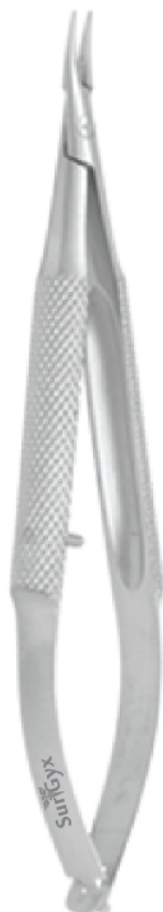

Castroviejo
Needle Holder
short model
very delicate jaws
curved
NH-60-1026 with lock
NH-60-1027 without lock

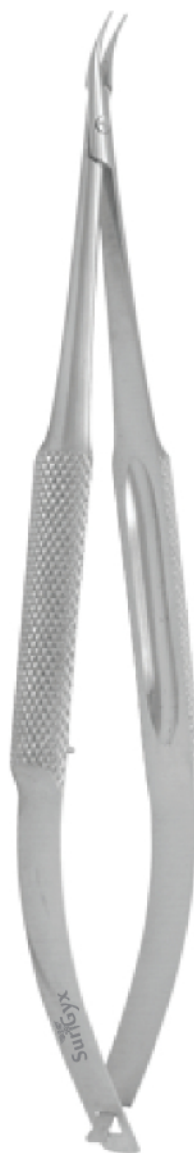

Troutman
Needle Holder
delicate jaws
strongly curved
NH-60-1028 with lock
NH-60-1029 without lock



Barraquer
Needle Holder
very delicate jaws, curved
NH-60-1029 with lock
NH-60-1030 without lock
NH-60-1031 titanium, with lock
NH-60-1032 titanium, without lock

Barraquer
Needle Holder
delicate jaws
straight
NH-60-1033 with lock
NH-60-1034 without lock

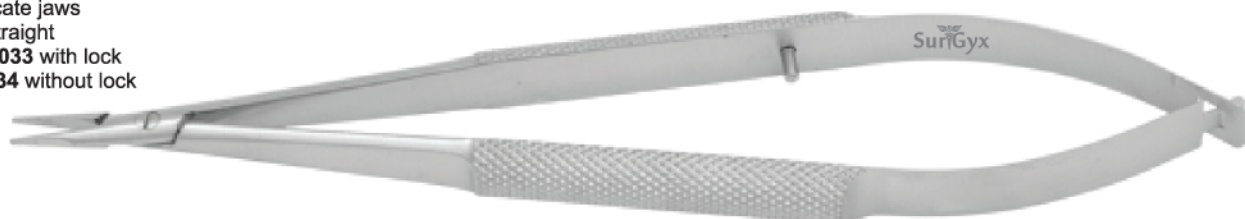



Barraquer
Needle Holder
delicate jaws, curved
NH-60-1035 with lock
NH-60-1036 without lock



Barraquer
Needle Holder
standard jaws, curved
NH-60-1037 with lock
NH-60-1038 without lock
NH-60-1039 with lock, titanium
NH-60-1040 without lock, titanium



Anis
Needle Holder
extra delicate jaws
NH-60-1041 with lock straight
NH-60-1042 without lock straight
NH-60-1043 with lock curved
NH-60-1044 without lock curved



Micro Needle Holder
Needle Holder
extra delicate jaws, straight
NH-60-1045 with lock
NH-60-1046 without lock
NH-60-1047 titanium, without lock
NH-60-1048 titanium, without lock

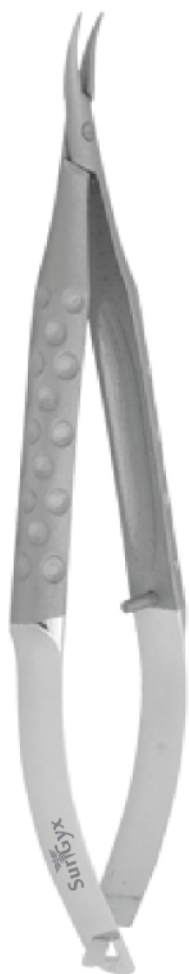

Barraquer (Golf Pattern)
 Needle Holder
 short model
 very delicate jaws, straight
NH-60-1049 with lock
NH-60-1050 without lock

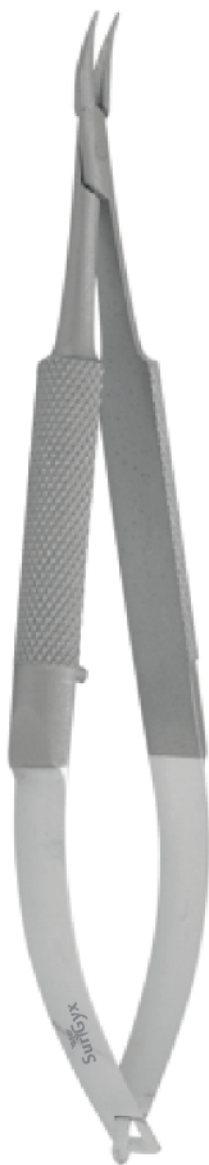

Barraquer
 Needle Holder
 short model
 very delicate jaws, curved
NH-60-1051 with lock
NH-60-1052 without lock



Micro Needle Holder
 Needle Holder
 delicate jaws
 strongly curved
NH-60-1053 with lock
NH-60-1054 without lock



Needle Holder
 delicate, curved, without lock,
 overall length: 115mm, titanium
 Ideal for 9-0 to 10-0 sutures
NH-60-1055 with lock
NH-60-1056 without lock
NH-60-1055 titanium, with lock
NH-60-1056 titanium, without lock

Barraquer
 Needle Holder
 delicate jaws, straight
NH-60-1057 with lock
NH-60-1058 without lock
NH-60-1057 titanium, with lock
NH-60-1058 titanium, without lock



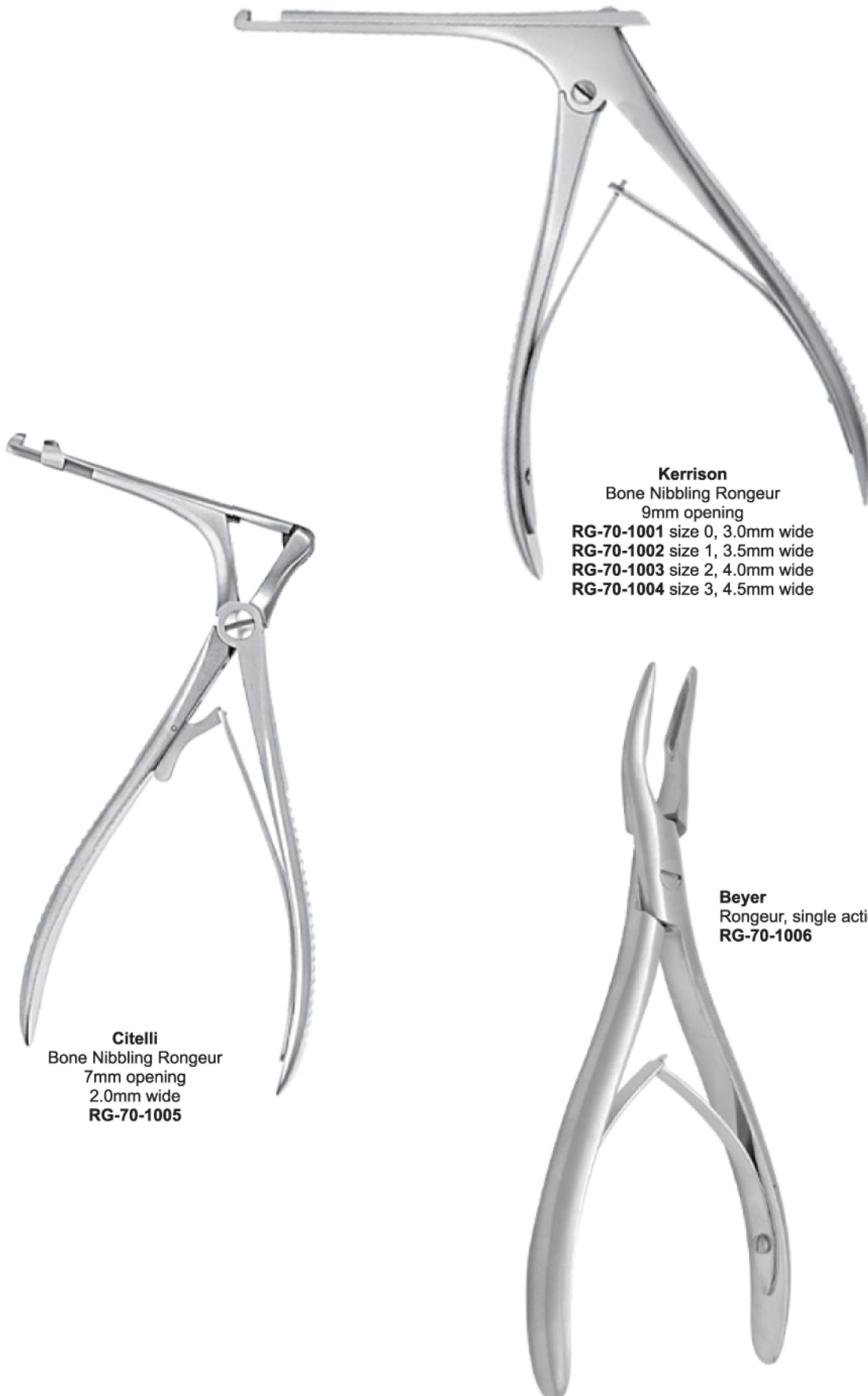

Citelli
 Bone Nibbling Rongeur
 7mm opening
 2.0mm wide
RG-70-1005

Kerrison
 Bone Nibbling Rongeur
 9mm opening
RG-70-1001 size 0, 3.0mm wide
RG-70-1002 size 1, 3.5mm wide
RG-70-1003 size 2, 4.0mm wide
RG-70-1004 size 3, 4.5mm wide

Beyer
 Rongeur, single action
RG-70-1006



Nasal Speculum
LI-70-1007 infant
LI-70-1008 child
LI-70-1009 adult



Freer Periosteal Elevator
one end blunt
other end semi-sharp
4.5mm wide blades
LI-70-1010



Joseph Periosteal Elevator
gently curved tip
LI-70-1011



West Lacrimal Chisel
straight
LI-70-1012

Freer Lacrimal Chisel
curved
LI-70-1013





Mallet
lead filled
stainless steel head
LI-70-1014

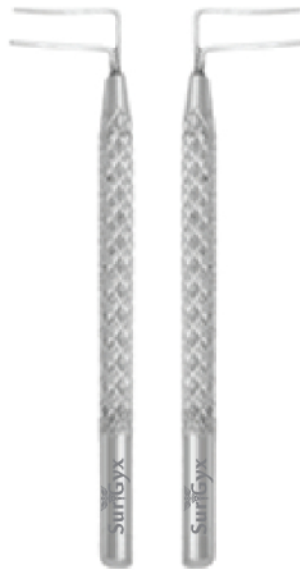

Harms
Trabeculotomy Probe
LI-70-1015



Infant
Lacrimal Dilator
very fine blunt tip
LI-70-1016



Muldoon
Lacrimal Dilator
LI-70-1017

Wilder
Lacrimal Dilator
LI-70-1018 size 1, fine taper
LI-70-1019 size 2, medium taper
LI-70-1020 size 3, heavy taper

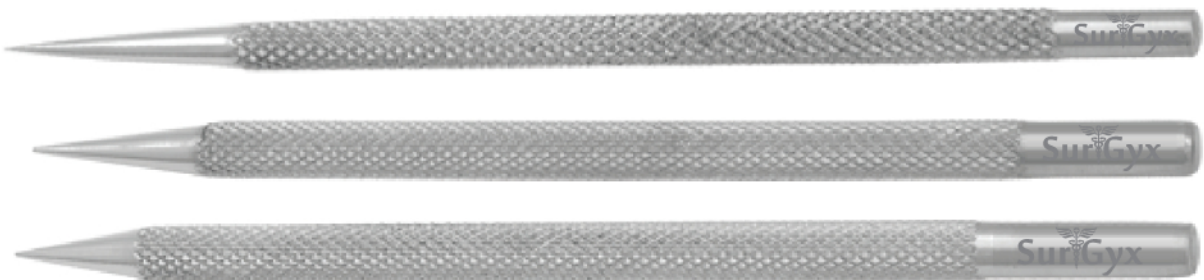



Castroviejo
 Lacrimal Dilator
 double-end
 fine and medium taper
LI-70-1021



Catalano
 Lacrimal Intubation Set
 includes 2 blunt
 0.7mm diameter probes
 attached to 30.5cm long
 silicone tubing
LI-70-1029 set
LI-70-1030 silicone tubing only



Crawford
 Lacrimal Intubation Set
 includes 2 olive tip
 0.6mm diameter probes
 attached to 30.5cm long
 silicone tubing
LI-70-1031

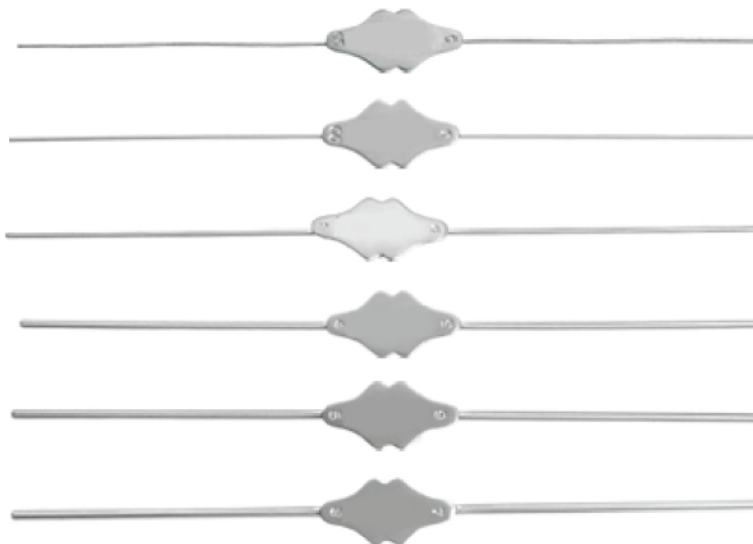

Bowman
 Lacrimal Probe
 malleable stainless steel
LI-70-1022 set of 6
LI-70-1023 size 0000 & 000
LI-70-1024 size 00 & 0
LI-70-1025 size 1 & 2
LI-70-1026 size 3 & 4
LI-70-1027 size 5 & 6
LI-70-1028 size 7 & 8

Crawford
 Retrieving Hook
 for Crawford lacrimal
 intubation probes
LI-70-1032



Pigtail
 Probe
 with suture holes
LI-70-1033



Cannulas

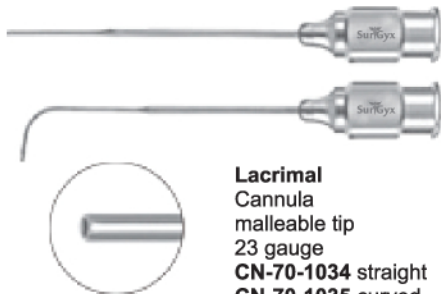

Lacrimal
 Cannula
 malleable tip
 23 gauge
CN-70-1034 straight
CN-70-1035 curved



Shahinian
 Lacrimal Cannula
 bullet shaped tip
 0.3mm side port
 23 gauge, 11mm long
CN-70-1036

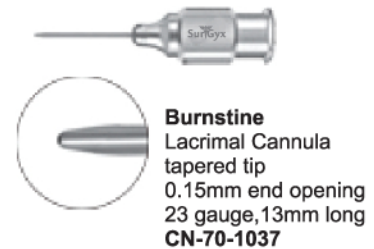

Burnstine
 Lacrimal Cannula
 tapered tip
 0.15mm end opening
 23 gauge, 13mm long
CN-70-1037

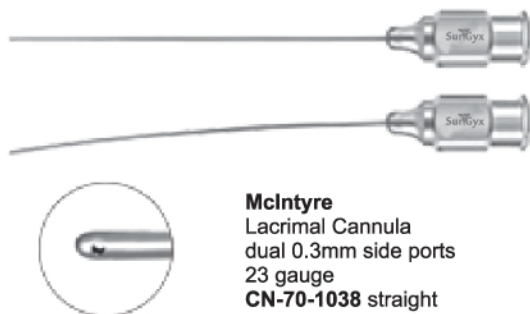

McIntyre
 Lacrimal Cannula
 dual 0.3mm side ports
 23 gauge
CN-70-1038 straight
CN-70-1039 curved

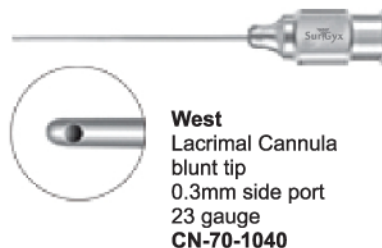

West
 Lacrimal Cannula
 blunt tip
 0.3mm side port
 23 gauge
CN-70-1040

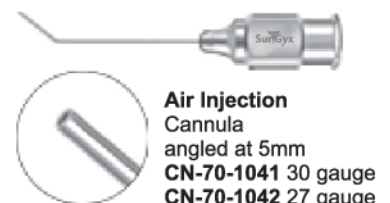

Air Injection
 Cannula
 angled at 5mm
CN-70-1041 30 gauge
CN-70-1042 27 gauge

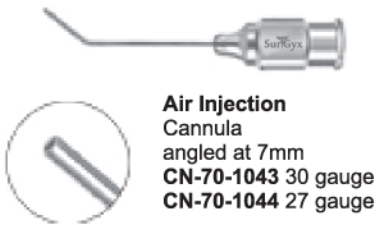

Air Injection
 Cannula
 angled at 7mm
CN-70-1043 30 gauge
CN-70-1044 27 gauge

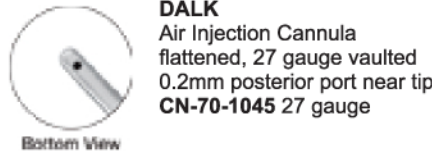

DALK
 Air Injection Cannula
 flattened, 27 gauge vaulted
 0.2mm posterior port near tip
CN-70-1045 27 gauge

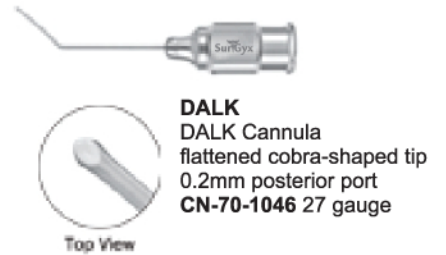

DALK
 DALK Cannula
 flattened cobra-shaped tip
 0.2mm posterior port
CN-70-1046 27 gauge



LASEK
 Alcohol Cannula
 delicate olive shaped tip
 angled at 10mm
 25 gauge
CN-70-1047

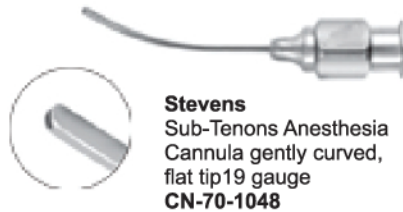

Stevens
 Sub-Tenons Anesthesia
 Cannula gently curved,
 flat tip 19 gauge
CN-70-1048

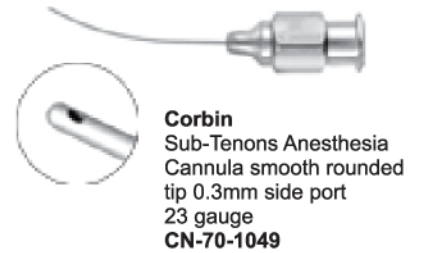

Corbin
 Sub-Tenons Anesthesia
 Cannula smooth rounded
 tip 0.3mm side port
 23 gauge
CN-70-1049

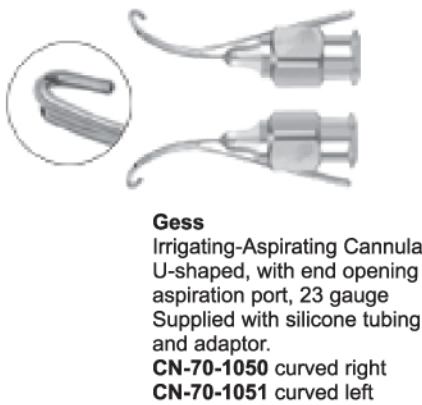

Gess
 Irrigating-Aspirating Cannula
 U-shaped, with end opening
 aspiration port, 23 gauge
 Supplied with silicone tubing
 and adaptor.
CN-70-1050 curved right
CN-70-1051 curved left

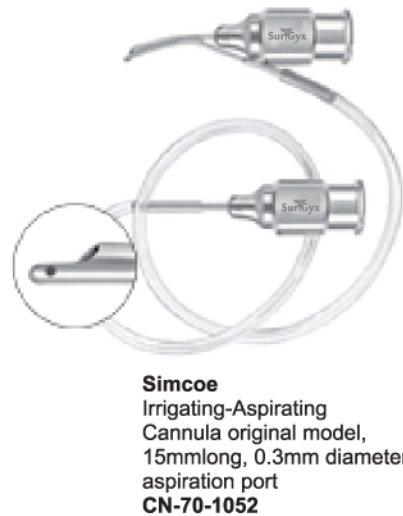

Simcoe
 Irrigating-Aspirating
 Cannula original model,
 15mm long, 0.3mm diameter
 aspiration port
CN-70-1052

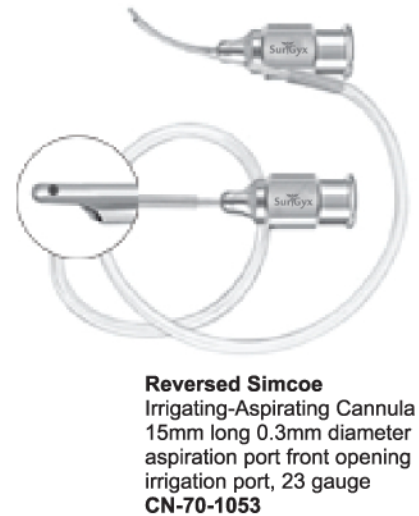

Reversed Simcoe
 Irrigating-Aspirating Cannula
 15mm long 0.3mm diameter
 aspiration port front opening
 irrigation port, 23 gauge
CN-70-1053

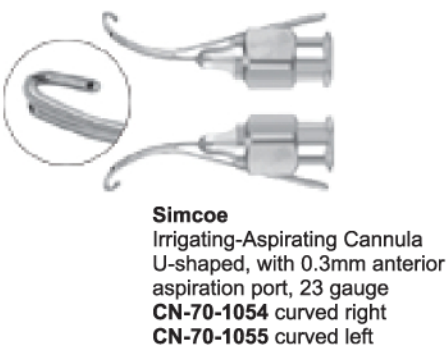

Simcoe
 Irrigating-Aspirating Cannula
 U-shaped, with 0.3mm anterior
 aspiration port, 23 gauge
CN-70-1054 curved right
CN-70-1055 curved left

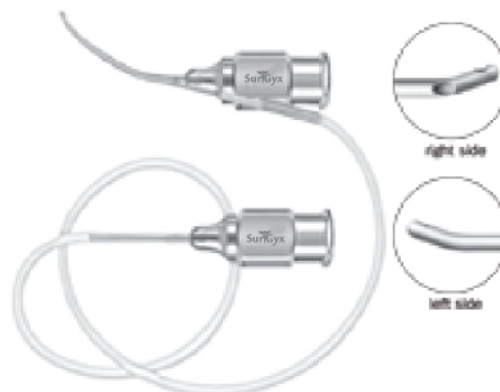

Strauss-Simcoe
 MSICS I/A Cannula
 23 gauge, 0.3mm port
 elongated and gently curved
 with 15° angled tip.
CN-70-1056



Kratz
Cystotome
sharp point and
sharp cutting edge
formed, 22 gauge
CN-70-1057

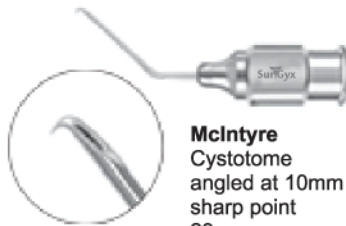

McIntyre
Cystotome
angled at 10mm
sharp point
23 gauge
CN-70-1058

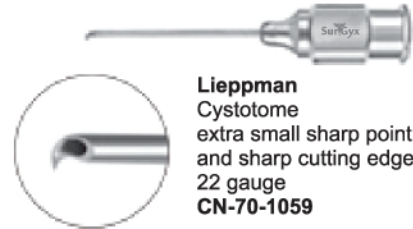

Lieppman
Cystotome
extra small sharp point
and sharp cutting edge
22 gauge
CN-70-1059

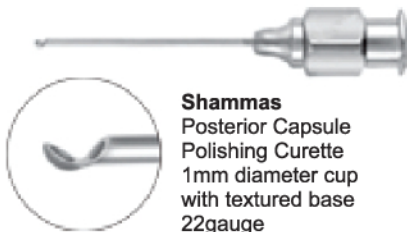

Shammas
Posterior Capsule
Polishing Curette
1mm diameter cup
with textured base
22gauge
CN-70-1060

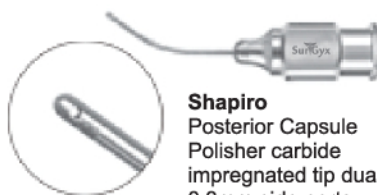

Shapiro
Posterior Capsule
Polisher carbide
impregnated tip dual
0.3mm side ports
curved, 23 gauge
CN-70-1061

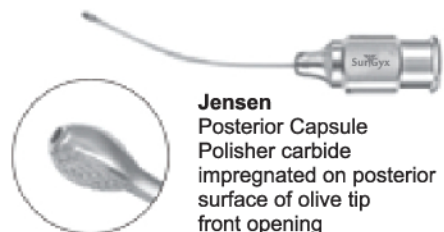

Jensen
Posterior Capsule
Polisher carbide
impregnated on posterior
surface of olive tip
front opening
CN-70-1062 25 gauge
CN-70-1063 23 gauge

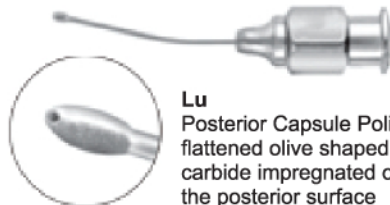

Lu
Posterior Capsule Polisher
flattened olive shaped tip
carbide impregnated on
the posterior surface
front opening, 23 gauge
CN-70-1064



Bishop-Harmon
Anterior Chamber Irrigator
includes 19 gauge angled
cannula, adaptor and blue
silicone bulb
CN-70-1065 complete
CN-70-1066 silicone bulb
and adaptor
CN-70-1067 silicone bulb
CN-70-1068 adaptor
CN-70-1069 19 gauge cannula
CN-70-1070 21 gauge cannula

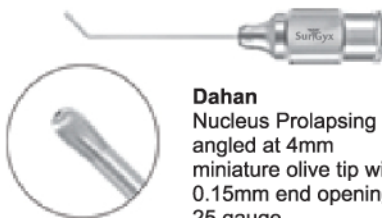

Dahan
Nucleus Prolapsing Cannula
angled at 4mm
miniature olive tip with
0.15mm end opening
25 gauge
CN-70-1071

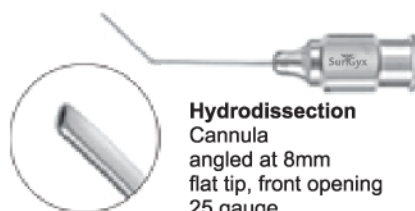

Hydrodissection
Cannula
angled at 8mm
flat tip, front opening
25 gauge
CN-70-1072

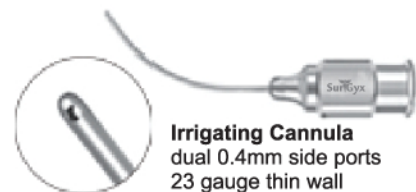

Irrigating Cannula
dual 0.4mm side ports
23 gauge thin wall
CN-70-1073



Fukasaku
 LASIK Cannula
 low profile tip, end
 opening, 23 gauge
CN-70-1074



Banaji
 LASIK Cannula
 bullet shaped tip
 6 ports for
 multi-directional
 irrigation 25 gauge
CN-70-1075



Buratto
 LASIK Cannula
 slightly flattened
 one front and two
 side ports
CN-70-1076 25 gauge
CN-70-1077 23 gauge

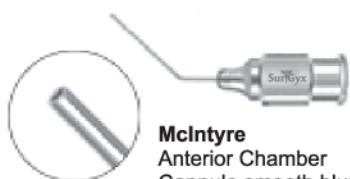

McIntyre
 Anterior Chamber
 Cannula smooth blunt
 tip, front opening
CN-70-1078 23 gauge, straight
CN-70-1079 23 gauge, angled
CN-70-1080 26 gauge, straight
CN-70-1081 26 gauge, angled
CN-70-1082 30 gauge, straight
CN-70-1083 30 gauge, angled

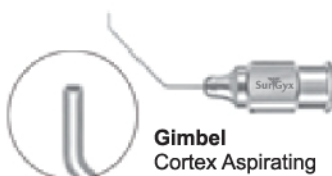

Gimbel
 Cortez Aspirating
 Cannula end opening
 30 gauge
CN-70-1084



Simcoe
 Cortez Extractor
 0.3mm side port
 21mm long, 23 gauge
CN-70-1085 smooth tip
CN-70-1086 textured tip



Vidaurri
 LASIK Cannula
 double-armed
 8 irrigating ports
 25 gauge
CN-70-1089 vertical
CN-70-1090 horizontal



Alfonso-McIntyre
 Irrigating Nucleus Spoon
 single 0.3mm
 front opening port
CN-70-1087 2.5mm wide
CN-70-1088 4.0mm wide



Simcoe
 Cortez Extractor
 0.3mm side port
 13mm long, 23 gauge
CN-70-1091 smooth tip
CN-70-1092 textured tip



McIntyre-Binkhorst
 Cannula, J shape
 smooth blunt tip
 end opening, 26 gauge
CN-70-1093 angled right
CN-70-1094 straight
CN-70-1095 angled left

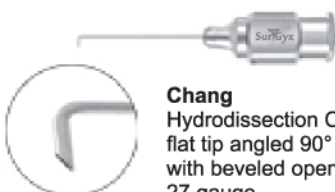

Chang
 Hydrodissection Cannula
 flat tip angled 90°
 with beveled opening
 27 gauge
CN-70-1096 standard tip
CN-70-1097 long tip

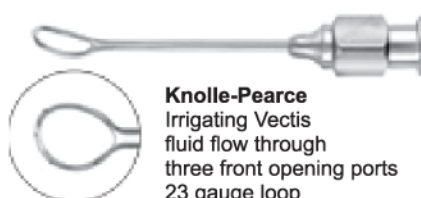

Knolle-Pearce
 Irrigating Vectis
 fluid flow through
 three front opening ports
 23 gauge loop
CN-70-1098



Simcoe
 Irrigating Lens Nucleus Loop
 two front opening ports
 finely serrated, strong curve
 25 gauge
CN-70-1099 right
CN-70-1100 left



InfusionHandle
IH-70-1101 male/male connectors
IH-70-1102 male/female connectors



Aspiration Handpieces

with male connector
 side port facing into curve
 magenta color

- IH-70-1103** 23 gauge, 0.3mm port
- IH-70-1104** 23 gauge, 0.3mm port, textured tip
- IH-70-1105** gauge, 0.35mm port
- IH-70-1106** 21 gauge, 0.35mm port, textured tip
- IH-70-1107** 21 gauge, 0.4mm port
- IH-70-1108** 21 gauge, 0.4mm port, textured tip
- IH-70-1109** 22 gauge, 0.3mm port, oval
- IH-70-1110** 22 gauge, 0.3mm port, oval, textured tip
- IH-70-1111** 20 gauge, 0.3mm port, oval



Irrigation Handpieces

with female connector, blue color

- IH-70-1112**
23 gauge, dual 0.3mm side ports
- IH-70-1113**
22 gauge, dual 0.4mm side ports, oval
- IH-70-1114**
21 gauge, dual 0.5mm side ports



DELIVERING PRODUCTS TO THE HEALING HANDS

Tax ID: 0105561085653



info@surgyx.com | www.surgyx.com
SurGyx Surgical Company Limited
233/90 Sanpawut Town Sanpawut Road,
Bangna Bangkok, Thailand 10260